

SUNlite

Shedding some light on UFOlogy and UFOs



Jacob's conjectures may mystify and amuse many and even seem persuasive to those without an appropriate background. That, plus the fact that the physical evidence is long since gone, is likely why myths continue to surround and degrade the historical significance of the Big Sur adventure.

Kingston George - Buzzing Bee missile mythology flies again



Cover: A launch of an Atlas D ICBM and the quote given indicates I am going to spend time this issue discussing the infamous Big Sur UFO case.

Left: The trail left by the launch of a Delta Four rocket on May 16, 2014. The launch was at sunset and gave an interesting illumination to the resultant contrail. A similar display was seen by residents of California and Nevada before sunrise on September 22, 1964.

TABLE OF CONTENTS

Who's blogging UFOs.....	2-3
The Roswell Corner	3
Joel Carpenter and the Big Sur case.....	4
The Big Sur UFO incident saga...5-8	
The Florenz Mansmann factor....	9-10
The Atlas D launch and trajectory.....	11
The Kwajalein Nike-Zeus radar system	12-13
Butterfly net and Buzzing Bee sighting reports.....	14
The Boston University Telescope.....	15-18
The documented record for Butterfly net and Buzzing Bee.....	19-20
UFO, misidentification, or hoax?.....	21-22
Breeding History by Marty Kottmeyer.. ..	23-31
UFO evidence under review: May 20, 1961	32-34
The 701 club: Case 2692 August 27, 1953.. ..	35-38
UFOs on the tube.....	39
Buy it, borrow it, bin it.....	39

Mr. Carpenter's missing opus

As I mentioned briefly in last issue, Joel Carpenter's death was very sad news for me because over the past decade or so, we have had several interesting e-mail exchanges about various UFO cases. Sometimes, we simply agreed to disagree but, for the most part, I felt our communications were cordial. The one case that Joel had spent time on in the last three to four years was the Big Sur case, which he had felt could be explained satisfactorily. He had obtained information that I felt was critical to the case and I often urged him to publish his research. Unfortunately, his death prevented his work from being completed. While Joel shared with me many of the documents he had obtained, he never gave me any rough drafts of his proposed article. I was hoping that others, who worked more closely with Mr. Carpenter, might have published what he had completed but I have heard or seen no indication that this might occur. As a result, I chose to use Joel's research to present my own interpretation of what it means. I want it to be clear that most of this information came from Joel Carpenter, as well as a few other unknown individuals who helped him. They deserve a good deal of the credit for what appears here. Hopefully, the article will be similar to what Mr. Carpenter wanted to present and will be a tribute to what would have been one of his finest works.

While looking at the Big Sur case, I noticed that various proponents of the case like to refer to those with an opposing argument as liars. I find that somewhat amusing because if any skeptic, scientist, or US Air Force representative used that word, there would be hell to pay from the UFO community and possible lawsuits filed. I want to think that a person might have been mistaken or incorrectly remembered something before calling them intentionally dishonest. In the case of Big Sur, I do NOT consider Robert Jacobs and Florenz Mansmann liars but I do think they were very mistaken about what they remembered. If Robert Jacobs and Robert Hastings want people to believe the Jacobs version of events, they need to provide solid evidence and not just "I know what I saw" because the documentation, as the reader will see, does not support their claims at all.

Due to problems with Comcast, I have now changed my website address to <http://www.astronomyufo.com/>. The SUNlite web page can be found at: <http://www.astronomyufo.com/UFO/SUNlite.htm>

Who's blogging UFOs?

Hot topics and varied opinions

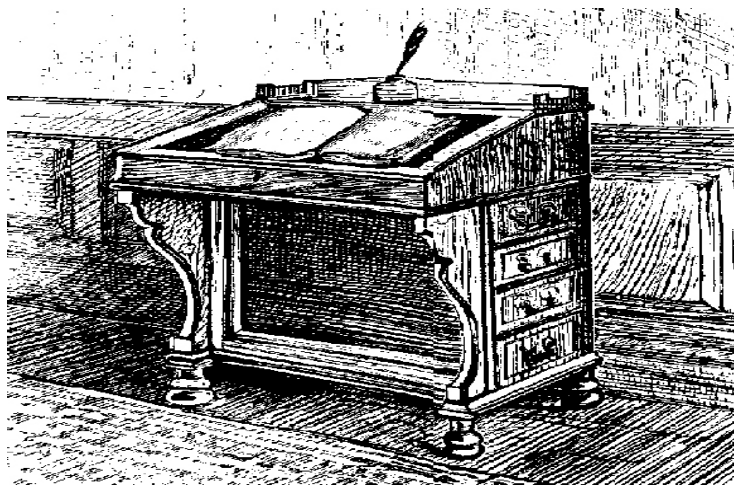

It is pretty bad when UFOlogists can not recognize a lens flare but I was shocked when a "photographer" was mystified by these effects. This "photographer" did not see these anomalies until after he looked at the photograph. That should normally be a red flag and I am surprised that somebody who runs a web site about photography is not familiar with these kinds of artifacts. If one looks at the directions of these "UFOs", which are in an arc in the upper half of the image, they all line up with the bright lights on the dock in the lower half of the photograph. Just because a person declares they are a "photographer" and takes nice pictures, does not mean they have an understanding of the optics they are using.

As if lens flares aren't bad, bug videos continue to plague UFO investigators, who are unaware of how they appear in videos. In this video, MUFON investigator Mark Podell made the proclamation that he has concluded that it was either an experimental US craft or some kind of off-world vehicle. He

never mentioned the possibility it might have been an insect. Apparently, the word is out for MUFON investigators not to call any video a possible bug, star/planet, or Chinese lantern when being interviewed by the media. The object was recorded by a quadcopter that had a camera and was sitting on the ground when the object was recorded. It went across the entire field of view, making it appear very fast. If it were a bug, then it was close and would have a large angular speed but a slow actual ground speed. It is important to point out that the camera was in focus even up close so the claim that a bug, that was close to the lens, would be out of focus just does not hold up.

Martin Clemens complained that skeptics blindly are accepting the explanation for the Petit Rechain photograph being a hoax. According to Clemens, skeptics don't even know who "Patrick" was and that means the claim of this being a hoax may, itself, be a hoax. This is not quite true and Clemens should have looked a lot closer. Mr. Clemens only referenced one article but seems to have missed others, which included the interview Auguste Meesen conducted with "Patrick" discussing the hoax. Mr. Patrick Marechal (his real name) has been interviewed by skeptics and proponents alike and there is no doubt he exists and that he was the photographer. I think Mr. Clemens needs to acquaint himself with the full story before commenting.

It has been a while since I mentioned a UFO story by Larry Lowe. He decided to become a mouthpiece for John Burroughs and keep the Rendlesham boat afloat by quoting him. Lowe, like some UFO writers, is little more than a parrot here. He cites Burroughs for a rather selective reading of the executive summary concerning Unidentified Aerial Phenomena in the UK. While Lowe/Burroughs claim that the report recognize that the "UAP are real", they choose not to tell the reader that the report hypothesizes that UAP are some sort of atmospheric/electric phenomena and never suggest they are alien spaceships or time travelers. I suggest readers actually read the report and then read Lowe/Burroughs biased interpretation. In my opinion, they are suffering from "selective reading". This is not unusual in UFOlogy. Sometimes, people see (or read) what they want to see (or read).

I was not sure why I got an e-mail from Michael Horn about his support for the Billy Meier case until he began to reveal a bizarre plan where he could claim that skeptics would "endorse" Billy's photographs. Looking at the link, I immediately recognized this for the hoax that it is but Horn was insistent that he had indisputable proof of Meier's claims. Horn then demanded that skeptics prove that the photographs were a hoax **TO HIS SATISFACTION**. If they could not, Horn states:

Just so everyone knows, in about a week I'll be posting the names and info for all those opponents of the case who haven't successfully rebutted, refuted, "debunked", etc., the information and evidence I've provided, listing them as supporters of the case. In other words, they have the opportunity to post their own substantiated rebuttals to avoid being publicly listed as supporters of the authenticity of the Meier case. Seems pretty simple to me. Yer either fer it or still agin' it.

This type of chicanery demonstrates Horn is nothing more than a UFO con man. All Horn is proving by resorting to such nonsense is that he has failed to convince anybody with the evidence.

Is there really anybody, outside of a small minority, that really believe the stories that Billy Meier has told and the photographs/films he has presented? I think that Horn's case is best described by Carl Sagan in [The demon haunted world](#):

One of the saddest lessons of history is this. If we've been bamboozled long enough, we tend to reject any evidence of the bamboozle. We're no longer interested in finding out the truth. The bamboozle has captured us. It's simply too painful to acknowledge, even to ourselves, that we've been taken. Once you give a charlatan power over you, you almost never get it back.

Horn either can't admit he has been hoodwinked, which indicates he is a simpleton, OR he is part of the hoax, which makes him a

Who's blogging UFOs? (Cont'd)

dishonest individual. Is Horn a fool or a liar? I will let the reader decide.

Back in SUNlite 5-1, I described how a wayward balloon of some kind had sparked UFO reports in October of 2012. In SUNlite 5-5, I reported that "Google" had stated the balloon was theirs. Now we read another article by Google, where they show the actual balloon that was launched and it definitely appears to be the same target photographed by amateur astronomer Allen Epling in his telescope. In Sunlite 5-5, I suggested the case may be closed. After seeing the image of the actual balloon, I think the case can be considered "solved".

Jack Brewer demonstrated that MUFON continues to embellish things in order to promote their organization. If "Hanger one" wasn't a black eye, now we have various MUFON officials not willing to give details about their announced collaboration with France's GEIPAN. The impression one is given is that both organizations are working together to scientifically study UFOs. However, Jack discovered that all that really is happening is MUFON is giving GEIPAN UFO reports they receive from witnesses in France. In return, GEIPAN is providing MUFON the results of their investigations of these specific reports. This does not appear to be the type of collaboration that MUFON wants everyone to believe.

David Clarke wrote about the unfortunate death of William Schaffner, who crashed his British Lightning aircraft off the north sea in September 1970. In 1999, UFO investigator Tony Dodd proclaimed that Schaffner had died pursuing a UFO. This was based on a rumor by an anonymous individual who stated they knew the truth. Clarke explained that Schaffner had actually been attempting to intercept a British Shackleton aircraft that was being used to test British defenses when his plane crashed into the sea. The stories about UFOs are just rumors and it is a shame that UFO "investigators" take such unreliable sources and use them to promote stories that are not true. This is not the first time proponents of UFO cases have resorted to this sort of thing. Some of the more prominent UFO cases (Roswell, Rendlesham, Kecksburg, etc.) have promoted some of the worst kind of wild speculation, rumors, and unreliable individuals to make claims that are just plain wrong.

James Fox is promoting his next move with the title "701: The number the government does not want you to know". This apparently is about the 701 "unidentifieds" in the Blue Book files. If this is what "701" signifies, then Fox is lying to the public already because that number comes directly from the USAF/US government! Who says there is a cover-up? Anyway, Fox needs to revise his number because SUNlite has demonstrated that some of the 701 can be explained. I am not stating that all can be explained but that number is definitely not accurate.

Gilles Fernandez posted a discussion about the famous 2007 Hessdalen photograph and a possible explanation. Gilles and his co-author, Christophe Spitzer Isbert, demonstrate that a probable solution involved Norwegian F-16s ejecting flare countermeasures during a training exercise. That kind of activity has been confused for UFOs before.

The Roswell Corner

The annual MOGUL offensive

Kevin Randle is back to repeating his same old tired arguments against project MOGUL and Roswell. This probably has to do with the fact that the annual pilgrimage to Roswell is about to occur. While he proclaims to be speaking about facts, he is actually presenting his own interpretation of the documentation. I, as well as many others, interpret them differently. I presented this all in my article "Crashology's last stand" in SUNlite 5-5 and Randle offers nothing new in his latest monologue. He is simply repeating the same old arguments in order to convince "the faithful", and himself, that MOGUL can't explain the events of Roswell. I am not going to repeat my arguments from SUNlite 5-5 since they still stand as a reasonable interpretation of the facts.

We will continue to hear this mantra over and over each year in order to validate the belief that an alien spaceship crashed at Roswell. Meanwhile, the rest of the world will continue to recognize that this interpretation of events is more a religious belief than an established scientific or historical fact.

More from the rumor mill

Rich Reynolds is at it again. He is hinting that the Roswell research team has found evidence that something occurred in the New Mexico desert that is totally unrelated to what was found at the Foster ranch. Reynolds even suggested that the Foster Ranch debris should be dismissed by those researching the case. Of course, this is all nothing more than rumor/hints at great revelations to come when the team makes their great slide revelation at some UFO conference or the Roswell festival. I seriously doubt the Roswell research team is going to admit that the Foster Ranch debris had nothing to do with an alien space ship crash after two decades of dreaming up all sorts of excuses for how the debris was switched and how MOGUL is not the solution to the debris. This indicates that Mr. Reynolds source is not directly part of the team or he is probably interpreting the "evidence" differently. Only time will tell if any "evidence" that is unearthed really is meaningful but, like the slides that mysteriously appeared, I expect there will be more hype than substance.

Joel Carpenter and the Big Sur case

In May of 2009, Joel Carpenter had contacted me about the Big Sur case and exchanged with me a few ideas he had about it. Initially, we discussed possible astronomical solutions where an astronomical object may have entered the field of view but quickly determined all were untenable. Over the next few days, he bounced some ideas back and forth with me but gave little indication what he was about to reveal. Then he sent me a document that was very pertinent to investigating the case. While Robert Hastings, Robert Jacobs, and Kingston George had all cited the 13 October 1964 preliminary report in their articles, nobody had been able to produce the final report, which might have more information on the subject. I was shocked when Joel e-mailed me a copy with the request to keep the information confidential. My first question was if he had contacted Kingston George about it. He confirmed that he had done so and George had told him that he thought the document had been destroyed. Not only did this document have selected frames from the "Buzzing Bee" launch, it also mentioned how well the telescope performed for the "Butterfly Net" launch of September 15th, which is supposed to be the launch that was interfered with by the UFO.

By September of 2009, Joel Carpenter had acquired another document that might help resolve the Big Sur UFO case. The e-mail had the interesting title of "CONFIDENTIAL PLEASE Big Sur: Toast". The document enclosed was a report for Nike-X operations at Kwajalein atoll for the month of September 1964. It specifically mentioned how well the radar systems tracked incoming re-entry vehicles from the two Atlas launches in question. Needless to say, I was excited about Joel's findings and asked him when he planned on publishing his work. His answer was "soon". I patiently waited and held my tongue hoping that the work would be complete within a reasonable amount of time. Joel would occasionally e-mail me with bits and pieces he had done for his work but it seemed that he was never completely finished. Mr. Carpenter was a pretty thorough individual and it appeared that he was just trying to make sure he had all the bases covered on this one.

Joel Carpenter implied that it was originally a collaborative effort between he and one or more researcher(s) and that he hoped to publish it in the International UFO reporter (IUR). Over the years, that collaboration between he and other researchers seemed to wane and Joel was apparently left trying to complete the work on his own. In May of 2010, he confided to me that he had reservations about publishing a work that could paint Robert Jacobs as a dishonest individual and feared it may result in a lawsuit of some kind. It is too bad that the arrogance of Jacobs was so great that it may have intimidated Carpenter to the point that he never finished his work. In an apparent attempt to get Robert Hastings to change his tune, Joel told me that he had contacted him with the information he had obtained. I was also under the impression that he had shared some of the documents with Hastings. According to Mr. Carpenter, Hastings' response was composed of "abuse and bluster". If this is true, it appears that Hastings was not interested in the facts but was more interested in continuing to promote the story as told by Jacobs.

It is too bad that Mr. Carpenter did not complete his work and I feel somewhat reluctant in presenting HIS research in MY words. However, if I did not do it, I am not sure if anyone else would. Joel failed to publish because he never completed the work or others influenced him not to be hasty about it. What I hope to present here is much of what he shared with me and add additional information that I had discovered.

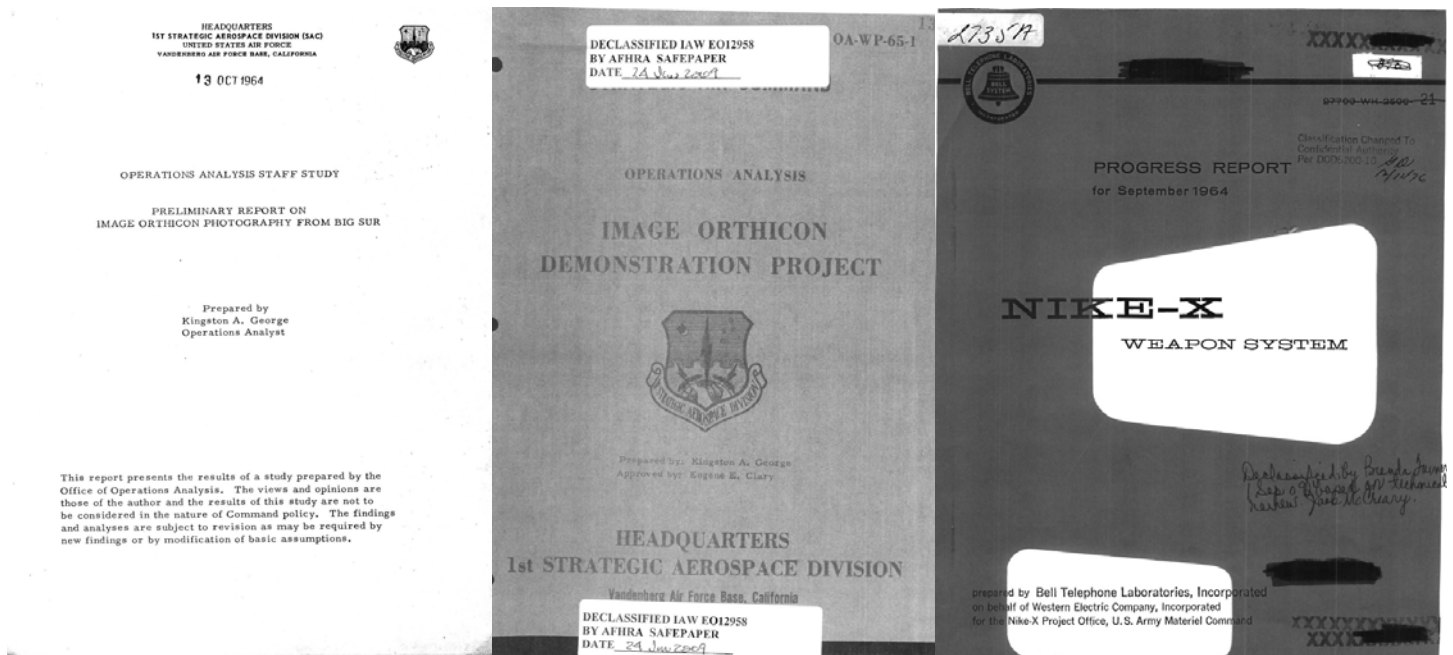

Three documents that tell the real story about the Big Sur Atlas missile launches in September 1964. The first is the Preliminary report on the Image Orthicon Photograph from Big Sur by Kingston George. This document has been mentioned by George, Jacobs, and Hastings in their articles. The other two documents were not seen/mentioned by these authors. Joel Carpenter and his associates acquired these documents, which help clear the air on the case. The Operational Analysis of the Image Orthicon Demonstration Project by Kingston George is a more extensive report than the preliminary report and includes details about the launches including actual frames from the "Buzzing Bee" film. The Nike-X progress report for September 1964 presents information about how well the Atlas "D" missiles and payloads were tracked by the Nike-X radar systems from Kwajalein atoll.



The Big Sur UFO incident has become part of the UFO case book for over three decades. The evolution of the story and the arguments against it over the years is something the reader should be aware of before elaborating on other details that affect the case.

All aboard the SS Jacobs

The story was first revealed to the public by Robert Jacobs in the October 12, 1982 National Enquirer. This brief article was reproduced in Flying Saucer Review in October of 1983. According to that article, Jacobs states the missile, an Atlas F launched on January 8, 1965, was shot down by a UFO when it was at an altitude of 60 miles:

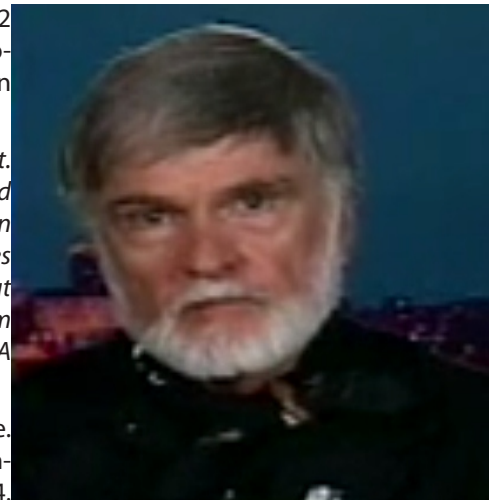

*Suddenly we saw a UFO swim into the picture. It was very distinct and clear, a round object. It flew right up to our missile and emitted a vivid flash of light. Then it altered course and hovered briefly over our missile...and then there came a second vivid flash of light. Then the UFO flew around the missile twice and set off two more flashes from different angles and then it vanished. A few second later, our missile was malfunctioning and tumbling out of control into the Pacific Ocean, hundreds of miles short of its scheduled target....The film was turned over to the two men in plain clothes from Washington, who I believe were CIA agents. **The film hasn't been heard of since.** ¹*

The next version of the story appeared in the January 1985 issue of Omni Magazine. Eric Mishara managed to contact Florenz Mansmann, Jacob's superior officer, who confirmed the story. The date for the event was determined to be September 15, 1964. Mishara also contacted Vandenberg, who responded that the missile launched on that date was not shot down and had hit the target. ²

This story was pursued by T. Scott Crain in the September 1988 MUFON Journal. Like Mishara, he talked to Mansmann, who confirmed the story told by Jacobs. When Crain discussed the case with Mishara and his source from Vandenberg, Mishara stated it was a Sergeant Lorri Wray from the base Public affairs office. Crain could not contact Wray and Mansmann had issues with this statement about the warhead reaching its target. According to Crain:

Mansmann claims the statements made by the AF spokesman makes no sense. If the Air Force spokesman did review a close-dated launch and saw nothing, it could not have been the launch that perpetuated such quick security action. ³

When Crain tried to contact that office, the USAF stated there were no such records of an Atlas F being launched on September 15, 1964. The confusion may have been caused by Jacobs' claim that it was an Atlas F. The launch on September 15th, was an Atlas D.

Jacob's second version of the story appeared in the MUFON journal of January 1989. His article took on the title of "*Deliberate deception*". In that article, there was some revisions performed. The date of the launch was determined to be September 2, 3, or 15, 1964. The missile type was still an Atlas F but Jacobs suggests it might have been a D instead. He added that this test was designed to defeat radar detection. According to Jacobs, the rocket was huge in the filming and the lower third of the rocket filled the field of view. Jacobs also pointed out that at T+400 seconds (well after re-entry vehicle separation from the main booster), the nose cone

was still being tracked. At this point, nobody noticed anything unusual. It was not until the film was reviewed by Mansmann that the UFO event was seen:

*Another object **flew into the frame** from left to right. It approached the warhead package and **maneuvered around it**. That is, this ... "thing"...flew a relative polar orbit around our warhead package which was itself heading toward the South Pacific at some 18 thousand miles an hour!*

As the new object circumnavigated our hardware, it emitted four distinct bright flashes of light at approximately the 4 cardinal compass points of its orbit. These flashes were so intense that each "strike" caused the I.O. tube to "boom" or form a halo around the spot. Following this remarkable aerial display the object departed the frame in the same direction from which it had come. The shape of the object was that of a classic "flying saucer." In the middle of the top half of the object was a dome. From that dome, or just beneath it, seemed to issue a beam of light or which caused the flashes described.

Subsequently the warhead malfunctioned and tumbled out of suborbit hundreds of miles short of its target. This ... unidentified flying ... "thing" had apparently "shot down" an American dummy atomic warhead!⁴

Jacobs then went on to hypothesize why the telescope was present for this important event.

(5) Most probably the B.U. Telescope was brought out to California specifically to photograph this event which had been prearranged. That is, we had been setup to record an event which someone in our Government knew was going to happen in advance.

(6) What we photographed that day was the first terrestrial demonstration of what has come to be called S.D.I. or "Star Wars." The demonstration was put on for our benefit for some reason by extraterrestrials. It is this aspect of the event, not merely the recording of another "flying Saucer" which caused such consternation both on the part of Major Mansmann when he told me "it never happened" and on behalf of the government in its two and one half decade coverup of the event and the record we made of it.⁵

As proof that something out of the ordinary occurred, Jacobs presented a document with the title of "Preliminary report on image orthicon photography from Big Sur", which was written by Kingston George in October of 1964:

*In this document, "King" George gives us a quick sketch of the whole Big Sur project, tells us that "Over the period of 30 days, from 31 August to 30 September, during which the Boston University telescope was ready to film launches, eleven flights were made from Vandenberg," that "a final report will be forthcoming in a few weeks with a complete description of the system and the operations over the past several weeks," that "a documentary film of about 30 minutes length containing several minutes of selected film clips will be assembled" and that **one powered flight anomaly was observed** (italics mine), and the coverage of the flights has produced enough data to show that Big Sur photography could be an important adjunct to other instrumentation."*

It is not clear whether or not Kingston George was privy to the screenings of the Big Sur film which recorded the UFO. My suspicion is that he was one of those to whom Mansmann has admitted showing the film. His document, however, states clearly that a missile malfunctioned during the B.U. test period, now putting the final lie to the Air Force denials.⁶

This is how the case stood for five years, until Kingston George decided to enter the UFological fray.

The ship springs a leak

In 1993, Kingston George responded with an article for Skeptical Inquirer, which presented a different version of events than what Jacobs described. According to George, the rocket launch that Jacobs was referring to was called "Buzzing Bee" and was filmed on September 22nd. This event involved an Atlas D that was the only launch of all the test flights that showed all the events that Jacobs and Mansmann described because of the time of day it was recorded. George recalls that the B. U. telescope recorded something unique but it was not a UFO. It had been able to record the decoy package deployment that was traveling in the trajectory with the actual test warhead. Most importantly, the film showed that one could tell the difference between the decoys and the actual Re-entry vehicle. Kingston George revealed that this prompted security regulations to be enforced on the film since what it recorded was classified.

Omitting the technical details, what had happened on Buzzing Bee was that two decoys were fired off by small rocket charges on schedule, but some of the decoy packing material also tailed along and could be seen optically and also by certain kinds of radar. A little cloud of debris around each decoy warhead clearly gave away the false status, almost as well as coloring the decoys bright red.

This, of course, led to more than a little consternation at SAC Headquarters and in higher military circles. Although correctable by re-design, the alarm in the minds of the strategic analysts was that the Soviets could defeat our ICBM decoys by using a few telescopes on mountain peaks in the USSR and relaying information on which objects were decoys to the Soviet ICBM defense command center. An immediate concern was that, although few understood its significance, a raft of people at Vandenberg AFB had seen the data. Vulnerability of a major weapons system is normally classified Top Secret. How could this matter be kept from leaking out?...

As might be expected, the military reaction came swiftly. Everyone who was at the telescope site or had seen the film had to be identified. All, including Jacobs and myself, had to be questioned on what they had seen and what they thought it meant. Each was cautioned not to mention what was on the film to anyone and not to discuss it with others -- even fellow workers who had originally seen it at the same time! None of us had more than a guess at the meaning, and the civilian intelligence experts who did the "debriefing" gave no hints.

Weeks later, my clearance level was increased to allow me to see the films again and analyze them. I don't think Bob Jacobs ever gained

the required clearance. The people later assigned to operate the equipment and carry the films around were subsequently cleared to the required level. The Top Secret film was marked for downgrading and declassification after 12 years, but its utility was over after a few months. Top Secret storage is too difficult and expensive for keeping items of dubious worth, and the film and related materials were all destroyed long before the 12 years were up.⁷

As for Jacobs' claim that the event was all prearranged for the B.U. telescope to be there so it could witness this event of an alien interfering with a dummy warhead, Kingston George found it very unlikely. He recalled that it took a lot of effort to get the scope there in the first place and there seemed to be little cooperation/help to accomplish the task:

My supervisor at the time, Gene Clary, and I would have been thrilled to have had any kind of support from anywhere in the Government! The truth is, getting permission to use the national forest site, arranging air and ground transportation, finding \$50,000 to pay the air freight, and attending to myriad other physical and monetary obstacles, took us the better part of nine months.⁸

On a final note, Kingston George pointed out that there was no UFO and the mission was a success with no loss of a re-entry vehicle.

Trying to plug the holes

By 2007, Robert Hastings stepped into the arena as he attempted to promote his book about UFOs and nuclear weapons. He wrote an article for the *International UFO Reporter* with the title, "A shot across the bow: Another look at the Big Sur incident". In that article, Hastings presented letters that Florenz Mansmann and Robert Jacobs wrote about the incident in the 1980s as critical evidence to support Jacobs' version of events. He also criticized Kingston George for misquoting Jacobs on several small items and then argued that the B. U. Telescope should have been able to resolve the UFO. He also quotes Jacobs as stating:

I recently asked Jacobs to elaborate upon his earlier published comments relating to the number and type of objects visible in the field of view just before and during the shoot-down event. He responded, "We saw the nose cone separate and open up—it looked like an alligator's open jaws. We saw the experiment, which was metallic chaff, come out. We saw the dummy warhead come out and inject into a different [trajectory]. All of the other components, the chaff and so on, were all still flying along. They don't lose altitude all that quickly because of momentum. So, there were several objects visible when the UFO came into view."⁹



Hastings then revealed that there was an Atlas D launched on the 15th and Jacobs agreed that this was the launch he recalled because of the time of day. Jacobs also denied being present at the telescope on the 22nd because his personal log states he was not there on that date. However, by his own words, he never saw the UFO event until he saw the film with Mansmann in the screening room. He did not have to be present at the telescope on the day the film was shot to have seen the UFO footage.

The fact that the 15th launched mentioned a Low Observable Re-entry Vehicle was what convinced Jacobs that the 15th was the Atlas that he remembers was shot down by the UFO:

Jacobs's response was emphatic, "No, we were testing the RV itself. It was not a target test." He then elaborated, "There were several interesting aspects of the anti-missile missile tests. This particular one involved a dummy warhead and a bunch of radar-deflecting aluminum chaff. The dummy warhead was targeted to splashdown at Eniwetok Lagoon. . . . As far as I know Kwajalein [played no part in this test] aside from radar tracking. There was no planned Nike launch [involved with it]."²¹

Given this unequivocal statement, the question remains: Did George select and discuss the same missile test described by both Jacobs and Mansmann? The entries in Jacobs's original mission log, as well as the now-available data published by Encyclopedia Astronautica, appear to indicate that he did not, thus negating much of the force of George's critique.¹⁰

One thing missing from this article is the presentation of Jacobs' "Original mission log" (sometimes referred to as a personal log). If Jacobs had an "Original mission log" in his possession, why didn't he know the date of the UFO event and originally thought that it occurred in 1965? Its omission from the evidence presented indicates (assuming it actually exists) that nothing of importance was in this document. Despite being unable to prove that the 15th was the launch in question, Hastings then proceeded to go into a conspiracy rant, where he chose to imply that Kendrick Frazier, Philip Klass, and Kingston George were all part of the cover-up.

The decks are awash

Kingston George would respond with another *Skeptical Inquirer* article in 2009 with the title of "Buzzing Bee mythology flies again". In that article, George describes how the B. U. Telescope really had difficulty resolving details at the time of the warhead RV and decoys being released. The tank from the rocket was reflecting light and was a large blob while the RV and decoys were essentially

specks of light. More importantly, Mr. George restated that, in his professional opinion, the lighting conditions for "Butterfly Net", (the launch of the Atlas D on the 15th of September) were not favorable for tracking after the engines cutoff because the tracking operators would be unable to see the reflection of the rocket body/re-entry vehicle against the daylight sky:

*Butterfly Net was launched in the morning, long after sunrise, with a bright sky behind it. The image orthicon would have been adjusted for daylight. The manual trackers were handicapped after engine shutdown, when the vapor trail of engine fuel was depleted some 240 seconds after lift-off. Their inferior spotting scopes would not permit direct viewing for more than a few seconds.*¹¹

Unlike "Butterfly Net", "Buzzing Bee" was launched before sunrise and one could still track the targets because of the contrast between the rocket body reflecting sunlight and the dark sky. If this is correct, then "Buzzing Bee" was the only Atlas launch that could have been tracked after engine cutoff and shown the deployment of the re-entry vehicle as Jacobs and Mansmann described.

Abandon ship?

All of these articles about the Big Sur evidence are available on line if one knows where to look. As I have written previously, there appears to be four potential scenarios surrounding the story as told:

- The events are as Kingston George described and Mansmann/Jacobs confused the events over the years being influenced by their belief in alien visitation.
- Jacobs and Mansmann lied about the event occurring as they described.
- Some other test was being performed on one of the launches in September 1964 that was misinterpreted by Jacobs and Mansmann as an alien spaceship interfering with the warhead.
- Jacobs and Mansmann are telling the truth concerning what happened that September, have accurately recalled the event, and there is a massive cover-up by the US government (Kingston George and CSI being part of it) to hide the fact that aliens interfered with an Intercontinental Ballistic Missile test.

Since we have no evidence, other than anecdotal claims, that the incident involved an alien spaceship, it appears this is one of the least likely scenarios. Meanwhile, the anecdotal account given by Kingston George required no alien spaceships or conspiracies. His story presents a perfectly reasonable explanation making it a more plausible scenario. Which scenario is the most correct would require more evidence than what has been presented to date.

Notes and References

1. Jacobs, Robert. "How a UFO destroyed an American rocket. Former U.S. Air Force officer's revelation: The truth is too important to hide any longer. UFO spied on a space missile launch and I filmed it." Flying Saucer Review. October 1983. P. 24.
2. Mishara, Eric. "UFO Cover-up?". Omni magazine. January 1985. P. 87
3. Crain, T. Scott. "UFO Filmed Circling Atlas Rocket". MUFON UFO Journal. No. 245, September 1988. P. 11
4. Jacobs, Bob. "Deliberate Deception: The Big Sur UFO filming". MUFON UFO Journal, No. 249, January 1989. P. 6.
5. *ibid.* P. 7
6. *ibid.* P. 8
7. George, Kingston A. "The Big Sur 'UFO': An Identified Flying Object". Skeptical Inquirer. Winter 1993. P. 187.
8. *ibid.* P. 186.
9. Hastings, Robert. "A shot across the bow: Another look at the Big Sur incident". International UFO reporter. P. 10-11
10. *ibid.* P. 21
11. George, Kingston A. "Buzzing Bee mythology flies again". Skeptical Inquirer. January/February 2009. P. 45.

The Florenz Mansmann factor

One item that is used to verify the claims of Jacobs are the letters of Florenz Mansmann, who was part of the analysis team associated with the films. Shortly after Jacobs wrote his story, UFO investigators contacted Florenz Mansmann hoping to have him confirm the story. Mansmann did so in several letters that Robert Hastings shared with me several years ago in an effort to convince me, and other skeptics, that Jacobs story was authentic.

Some of the highlights from his January 30, 1983 letter to Lee Graham¹ were:

- The Enquirer story was true except the year was 1964 and not 1965.
- The camera system was capable of *"nuts and bolts"* imaging from a distance of 70 miles.
- He was concerned about information vital to humanity falling into the wrong hands.
- He hypothesized that there might be a super secret scientific study sending up these rockets to communicate with extraterrestrials. He concluded that two way communication will come soon.
- He also suggested that the United States has probably been selected by ET to be contacted because it is interested in bettering mankind and not destroying it.

This was followed by a March 3, 1983 response to Lee Graham answering questions he was asked.² The key points were:

- He did not know when Lookout Mountain analyzed the film because the film *"was rushed east on a special aircraft when we released it."*
- To his best recollection, it was the last Atlas launch from Vandenberg.
- General Wells was his commanding general.

Mansmann also responded to researcher Peter Bons on March 8, 1983, answering his questions.³ Some of the important items mentioned were:

- Bob (Jacobs) had opened a "pandora's box" with his story, which resulted him being bombarded with letters and requests.
- The Enquirer story was true except the year was wrong and it was in 1964.
- The assumption at the time was the object was extraterrestrial based on what was seen on the film.
- Based on his memory, *"the shape was classic disc, the center seemed to be a raised bubble, not sure if any ports or slits could be seen but was stationary, or moving slightly-floating-over the entire lower saucer shape which was glowing and "seemed" to be rotating slowly. At the point of beam release-if it was a beam, it, the object, turned like an object required to be in a position to fire from a platform....but again this could be my own assumption from being in actual combat."*
- Harvard University's computer scanning of data for Extraterrestrial signals might shed light on this case.

Four years later, on May 6, 1987, Mansmann communicated with Scott T. Crain⁴. He had told Crain the following:

- Bob Jacobs saw the film twice. Once in the film quality control room and once in the showing, which the CIA attended.
- He saw the film four times. Once in the film quality control. Once in the viewing for the General and one of his staff. Once in the viewing for the chief scientist and his assistant. The last involved Jacobs, the Chief Scientist and his assistant, the three government men, and Bob Jacobs.
- He ordered Bob Jacobs not to discuss the launch with anyone because of the nature of the launch, the failure of the launch, and that the film *"showed an interference with normal launch patterns"*.
- The object was saucer shaped but he was not sure if there was a dome.
- He did not know the names of the CIA personnel.
- He released the film to the Chief Scientist.
- He was ordered not to discuss the film.
- The stories told by he and Jacobs were factual.
- The response by Vandenberg that the missile performed normally and hit the target made no sense. If such records did exist, then it could not have been the launch he and Jacobs were describing.
- If the government wants to withhold such information, it may be related to the "Star Wars" program and it should be protected.

Finally, Mansmann wrote to Curt Collier of Paramount Pictures⁵ on November 15, 1995. In that letter, he mentioned:

- The Image Orthicon instrument was capable of photographing *"nuts and bolts"* and they had to be 70 miles away *"just to be in*

focus”.

- He confirms that Jacobs’ story is correct.
- He only saw the film three times. The final viewing involved the director of the Chief Scientist and his assistant, Two government agents, Bob Jacobs and himself.

These are the only communications by Mansmann that were sent to me by Robert Hastings back in 2008. They do give some insight into Mansmann’s mind set. He was very concerned about mission security associated with the launch and how information from that launch should not fall into the wrong hands. He also seemed to imply he was satisfied that aliens were visiting us and attempting communications. These factors may have influenced Mansmann in his recollections, which we can examine for accuracy.

There were two launches from Vandenberg on September 15, 1964. One was a Minuteman and the other was an Atlas D. So, Mansmann was correct on this point. However, according to the Astronautix web site, both missiles reached their target, which implies that the USAF was correct when it stated that there was no malfunction. This indicates that his recollections of this being the rocket launch, where an alien spaceship had interfered with the re-entry vehicle is not correct. In order for the Jacobs/Mansmann story to be correct, somebody (i. e. the US government) would have altered the data for the rocket launch so future historians would assume that it performed correctly..

Mansmann also stated it was the last Atlas D launch. It is hard to understand what he meant by this. It obviously was not the last Atlas D launch from Vandenberg because there were many more launched after September 1964. It was not the last Atlas D launched from Vandenberg for 1964 because, in addition to several missile firings in the latter part of 1964, there were others used to launch spy satellites.⁶ It was also not the last Atlas D launched as part of the BU telescope program. “Buzzing Bee” was launched on the 22nd and there was also an Atlas/Agena (mistakenly recorded in the IO documentation as a Thor/Agena) launched on the 23rd, which had placed a KH-7 satellite into orbit. While this is a simple mistake, it indicates that Mansmann’s memories are not to be considered perfect.

Another claim by Mansmann was the B.U. telescope had to be 70 miles away to get a rocket “in focus”. Perhaps he meant for tracking purposes. The actual choice of the location had more to do with the angle at which the telescope could view the launches. Like all other telescopes, the B.U. telescope probably could focus on objects much closer than 70 miles. Again, this is a simple mistake by Mansmann regarding details he probably was unfamiliar with.

However, the ability to see “nuts and bolts” from 70 miles away is something that needs to be examined. We don’t have any good imagery from the telescope showing this capability. I have no doubt that the actual rocket could be imaged but I am skeptical of the claim that it could see “nuts and bolts” without seeing films shot from this distance with the telescope.

What is important to note about the Mansmann letters is that the only thing they do is confirm that Mansmann remembered the events that occurred the same way Jacobs did. Of course, all of these letters were written AFTER Jacobs published his story and one has to consider the possibility that he was influenced by what Jacobs described in that original article. These letters, while important to mention and consider, are not positive proof that the story was accurately recalled.

Notes and references

1. Robert Hastings collection of letters involving Florenz Mansmann mailed to author in October 2008.
2. *ibid*
3. *ibid*
4. *ibid*
5. *ibid*
6. According to the Vandenberg launch log (<http://www.spacearchive.info/vafbblog.htm>) and astronautix web sites (<http://www.astronautix.com/chrono/1964.htm>), there were several Atlas D ICBM launches after “Butterfly net”. Buzzing Bee (Sept 22) Brook trout (Dec 1) Opera glass (Dec 4). There were also other launches in late 1964 that involved an Atlas D or F rocket. Four were Atlas/Agena D’s placing KH-7 spy satellites into orbit (Sept 23, Oct 8, Oct 23, and Dec 4) and one was an Atlas F ICBM launch on Dec 22.

The Atlas D launch and trajectory

Before examining the documentation, the reader will need to familiarize themselves with some of the events that transpired during an Atlas D Intercontinental Ballistic Missile (ICBM) launch. Many people are familiar with the Atlas because of its use during the Mercury space program. However, prior to Mercury, the Atlas was designed to be an ICBM that would deliver nuclear warheads to targets over 7,000 miles away. It was an interesting design which was often described as a one and half stage rocket.

The rocket was centered around a large tank where all the liquid fuel was present.¹ At the base of the tank was a rocket motor identified as the "sustainer engine". Surrounding the base of this stage was a booster assembly with two additional Booster engines. The purpose of this design was to have all the engines firing at launch. Once the boost phase was over, the booster engines were shutdown and booster assembly stage was jettisoned. However, the sustainer engine continued firing. Attached to the sides of the rocket were two Vernier engines used for attitude control. The continued to operate after the sustainer engine was shutdown. The image to the right shows this sequence of events except the end of the Vandenberg launches did not have a live warhead as depicted.²

The approximate time line of events for a standard Atlas launch was as follows³:

Event	T+ (approx)
BECO - Booster engine cutoff/Booster stage separation	135 seconds
SECO - Sustainer engine cutoff	281 seconds
VECO - Vernier engine cutoff	305 seconds (max)

About three to six seconds after VECO, the warhead, decoys (if applicable), and any other payloads would separate from what was left of the rocket body/fuel tank. A few seconds after payload separation, the rocket body would fire a series of rocket motors at the top of the rocket tank called the High Impulse Retrorocket system (HIRS).⁴ The purpose of these retro-rockets was to separate the rocket body from the reentry vehicle so it could be tracked on radar during the reentry phase.

After that, the rocket body and payload(s) traveled on a ballistic trajectory towards the Kwajalein island region of the Pacific Ocean, where a Nike-Zeus radar system was setup to monitor and track the incoming payloads.

Notes and references

1. USAF. Standard Missile Characteristics: SM-65F. January 1962. P. 2. Available WWW: <http://www.siloworld.net/DOWNLOADS/ATLAS%20F%20%20FACT%20SHEET/Atlas%20F%20%20Missile%20Fact%20Sheet.pdf>
2. USAF Air training Command. Missile Launch/Missile Officer student training guide OBR1821/3121-3. Sheppard technical training center. Sheppard AFB, Texas. 16 July 1963 P. 26 Available WWW: <http://www.siloworld.net/DOWNLOADS/OBR%201821-3121%20Reduced.pdf>
3. USAF. Characteristics Summary: SM-65D. February 1962. P. 2. Available WWW: http://www.alternatewars.com/SAC/CGM-16D_Atlas_CS_-_February_1964.pdf
4. Convair Division of General Dynamics. Atlas E/F Boosters and ABRES-A criteria for payload designers. General Dynamics. 20 October 1967. P. 8-3. Available WWW: <http://www.dtic.mil/dtic/tr/fulltext/u2/824972.pdf>

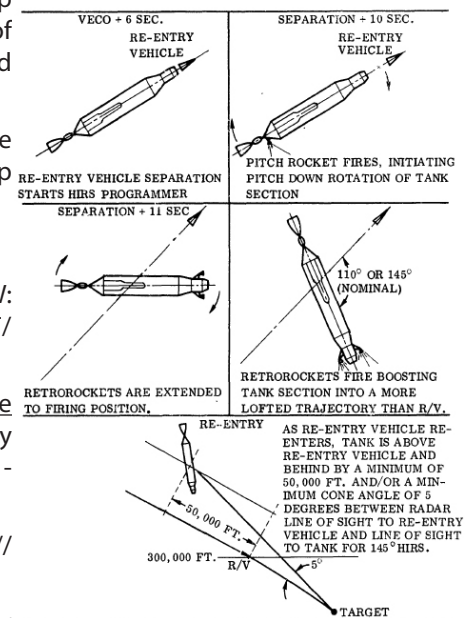
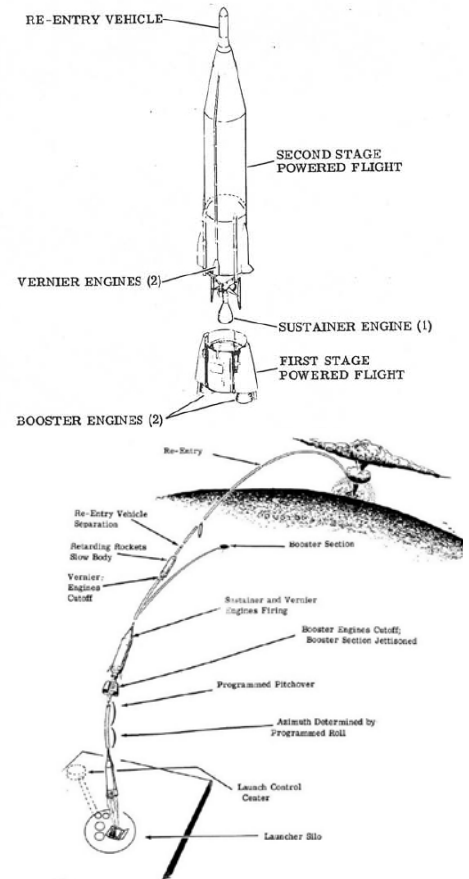

The Kwajalein Nike-Zeus radar system

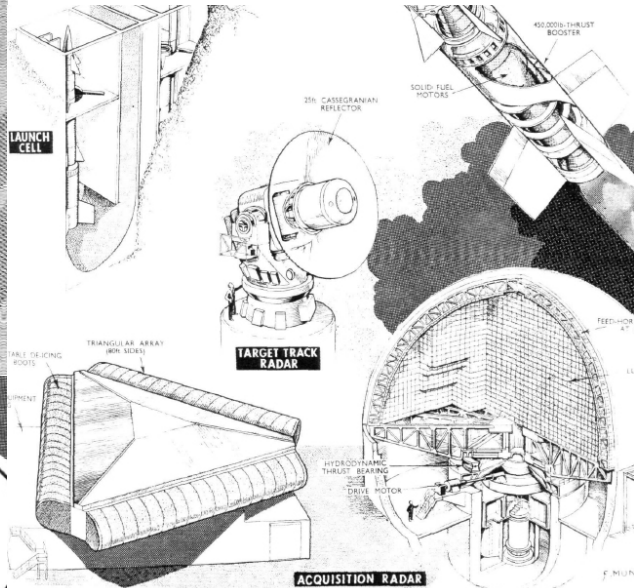
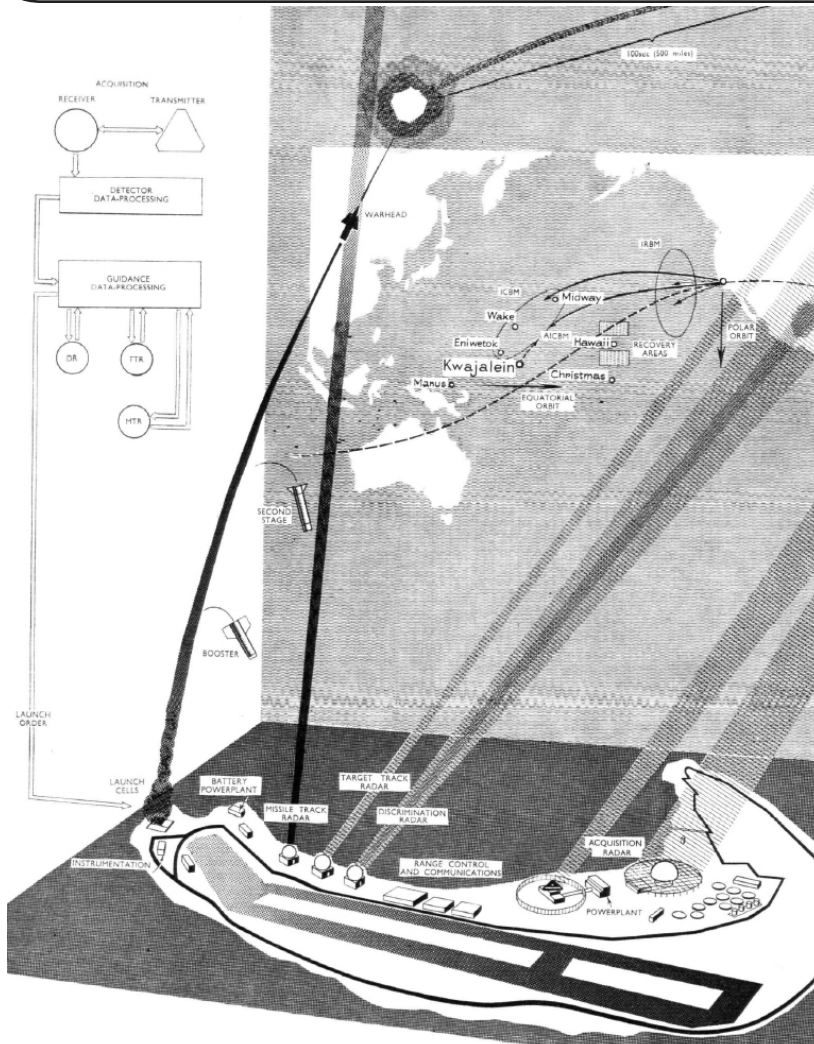

Two of the radar systems used to track the re-entry vehicles and decoys launched from Vandenberg. The ZAR (Zeus Acquisition Radar) and the Target Tracking Radar (TTR) systems were very sophisticated and were to be employed to launch Nike-Zeus missiles towards incoming targets. The top image shows an aerial photograph of the Kwajalein atoll. Notice the "beam forming clutter fence" around the triangular transmitting antenna.²

The Kwajalein island radar layout used to track incoming targets fired from Vandenberg AFB.¹

The Nike-Zeus system, which evolved into Nike-X, was designed to identify and track Intercontinental Ballistic Missile (ICBM) warheads in order to launch missiles to intercept them. The system never was proven to be a successful Anti-Ballistic Missile (ABM) defense but the Kwajalein Atoll had a fully operating radar system that was one of the most advanced at the time. If any UFOs had interfered with an Atlas missile launch, the Nike-Zeus radars would have been able to detect the effects of such interference.

The system was centered around several radars. The Zeus Acquisition Radar (ZAR) was designed to identify the presence of incoming targets. The computers took this information to point various radars at the targets. The Discrimination radar (DR) was designed to identify each target and identify the real warhead from any decoys. The target tracking radars (TTR) were supposed to track individual targets. Finally, the Missile track radars (MTR) were supposed to control the missiles sent up to intercept the targets.

The ZAR was a very interesting design, which was so complex that it had separate transmitting and receiving antennae. The transmitting antenna was actually three different transmitters, 120 degrees apart, which revolved at 3.3 RPM. This meant that any given target would have data on it updated every six seconds. The range of the radar was 600nm.³ The receiving antenna was a luneberg lens made up of small plastic foam blocks, impregnated with metal filaments, and a ground plane. These focused returning radio pulses into feeder horns that were on the perimeter of the hemisphere in arcs that were spaced 120 degrees apart.⁴

The ZAR transmitting antenna at Kwajalein was surrounded by a fence which was called a "clutter fence" or "beam forming fence". This fence was designed to prevent radar illumination of nearby ground targets that could interfere with tracking of airborne targets.

The discrimination radar was specifically designed to cover a target area of 22 nm out to a range of 500 nm.⁵ The antenna used a Cassegrain system that could focus the beam over the designed target area at any distance. The discrimination radar was surrounded by a clutter fence and was positioned close to the target tracking radars. The target tracking radars were also of the Cassegrain focus type. They were able to track targets at a distance of 580 nm if it had a cross section of 0.1m².⁶

The final bit of radar equipment was the MTR but, since missiles were not used to intercept targets launched from Vandenberg during this time period, I see no reason to go into any detail on this system.

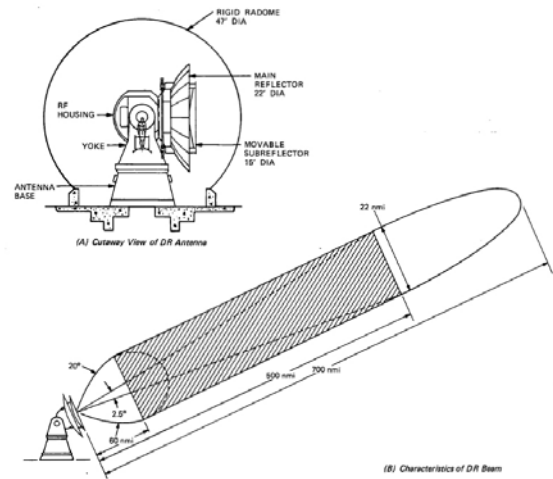

Left: A view of the discriminating radar (inside the clutter fence) and two of the target tracking radars (outside the clutter fence).⁷ Right: The discriminating radar antenna beam characteristics, which demonstrates how the cassegrain focus adjusted the beam focus.⁸

The Kwajalein Missile tracking site also had several optical tracking instruments to assist the radar and to evaluate the re-entry vehicles as they approached the target area. Several of these were mounted on an EC-121K "warning star" aircraft, which was used in the tracking of the payloads launched from Vandenberg. Others were ground based.

This entire array of radar and optical instruments allowed Kwajalein to monitor any missile launches from Vandenberg AFB that were targeted to land in their area. It seems very unlikely that the Kwajalein radar/optical tracking system would have missed any indications of a deviation from the missile's flight plan.

Notes and references

1. Gunston, W. T. "Missiles and spaceflight: Nike-Zeus". *Flight International* 2 August 1962. P.168-9. Available WWW: <http://www.flightglobal.com/pdfarchive/view/1962/1962%20-%201340.html>
2. Kwajalein island Pacific missile range facility post card. Available WWW: http://www.cardcow.com/images/set474/card00138_fr.jpg
3. ABM research and development at Bell Labs. *Project History*. Bell Laboratories. October 1975. P. 1-5 to 1-6 Available WWW: <http://srmsc.org/pdf/004438p0.pdf>
4. *ibid.* P. 1-7
5. *ibid.* P. 1-9
6. *ibid.* P. 1-16
7. US Army space and missile defense command/Army forces strategic command. *SMDC/ARSTAT Photo Gallery*. Available WWW: http://www.smdc.army.mil/smdcphoto_gallery/eagle/feb07/15-C02-06%20The%20many%20different%20radars%20of%20the%20NIKE-ZEUS%20system,%20ta.jpg
8. ABM research and development at Bell Labs. *Project History*. Bell Laboratories. October 1975. P. 1-11 Available WWW: <http://srmsc.org/pdf/004438p0.pdf>
9. *ibid.* P. 1-18
10. Wikipedia. *Lockheed EC-121K*. Available WWW: http://en.wikipedia.org/wiki/File:Lockheed_EC-121K_Rivet_Top_Korat_1968.jpeg

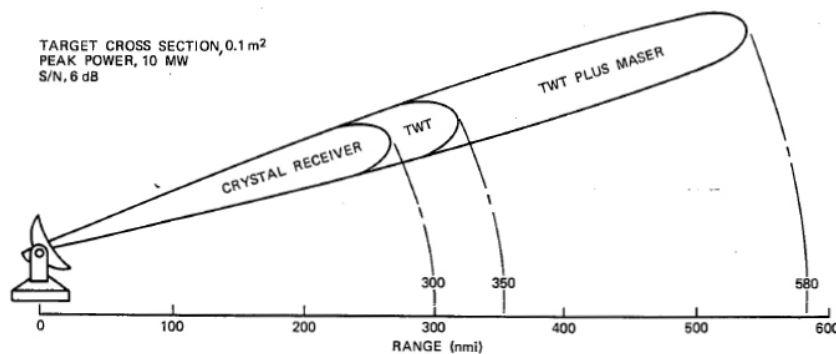

Left: The beam of the target tracking radar used to follow targets identified by the discriminating radar.⁹ Right: An EC-121K "warning star" aircraft, like this one, optically tracked the incoming targets using visual and infrared wavelengths.¹⁰

Butterfly net and Buzzing Bee sighting reports

The media accounts for Butterfly net and Buzzing Bee were very different. This had a lot to do with when the Missiles were launched. Butterfly net was launched after sunrise and, as a result, was not widely visible. However, Buzzing Bee was launched into a pre-dawn sky and was visible from many locations.

Butterfly Net - September 15, 1964

Missiles launched from Vandenberg

VANDENBERG AIR FORCE BASE — Air Force crews yesterday launched a Minuteman intercontinental ballistic missile (ICBM) and an Atlas ICBM from this Pacific Coast base.

The news accounts about this launch were very brief.¹ They simply reported that both an Atlas (designated Butterfly net) and Minuteman (designated Quick launch) missile had been launched from Vandenberg. Other than this brief announcement, outside observers seemed oblivious to a launch actually occurring. This probably had a lot to do with the visibility of the launch. Unless one were close to Vandenberg, the launch would not have been noticeable to the casual observer as it would only appear as a small contrail visible against a bright sky for just a few minutes.

Buzzing Bee - September 22, 1964

The media accounts of Buzzing Bee were far more numerous from the California news papers. The Modesto and Fresno papers described a contrail in the sky visible as far north as Ukiah, 335 miles north of Vandenberg. The San Mateo times² (right) described the event as "fireworks". As was the case when I lived in Florida, a rocket launch in darkness could be spectacular. In this instance, the rocket flame and the contrail, illuminated by the rays of the rising sun, contrasted well against the dark sky making it an obvious event to the casual observer.

1. DATE - TIME GROUP 22 Sept 64 22/1300Z	3. LOCATION Stead AFB, Nevada Honor Lake, Nevada, Carlsbad - Sacramento, California, Milford California
3. SOURCE Civilian and Military	10. CONCLUSION MISSILE ATLAS D
4. NUMBER OF OBJECTS One/Two	Missile launched from Vandenberg at 0603:48 Local. Atlas "D".
5. LENGTH OF OBSERVATION 5 Minutes	11. BRIEF SUMMARY AND ANALYSIS Bright fluorescent vapor rising from South to North at explosive speed. Maint at 45 deg angle. Disappeared slowly. Additional witness reported object heading in Southerly direction. Appeared to blow up. The object small light like reflected chrome with red glow from tail end. Space between object. Objects on straight course to West. Rapid speed. Smoke trail lasted two-three minutes after object had disappeared.
6. TYPE OF OBSERVATION Ground-Visual	
7. COURSE North-West	
8. PHOTOS <input type="checkbox"/> Yes <input checked="" type="checkbox"/> No	
9. PHYSICAL EVIDENCE <input type="checkbox"/> Yes <input checked="" type="checkbox"/> No	

FORM FTD SEP 63 0-529 (TDE) Previous editions of this form may be used.

While the California media figured out what was seen that morning, "trained observers" (air police officers) at Stead AFB near Reno, Nevada and other observers in northern California were mystified and filed UFO reports. Blue Book case 9113³ documents their observations. Buzzing Bee, because of the time of launch being just before sunrise, was a UFO report generator and this may have played a role in the events that were recalled by Mansmann and Jacobs.

Notes and references

1. "Missiles launched from Vandenberg". Oxnard Press-Courier. Oxnard, California. September 16, 1964. P. 2.
2. "ICBM Covers county with 'fireworks'". San Mateo times and daily news leader. San Mateo, California. September 22, 1964. P. 1.
3. "Project 10073 record card 22 September 1964". Fold 3 web site. Available WWW: <http://www.fold3.com/image/9421478/>

ICBM Covers County With 'Fireworks'

What was described as a "routine" launch of an ICBM from Vandenberg Air Force Base was anything but routine for hundreds of early risers in San Mateo County.

The missile made a spectacular display of celestial fireworks as it rose into the sky. And it left a condensation trail that lasted for several minutes.

Police departments throughout the county reported receiving scores of calls from curious residents.

A graphic description of the display was provided by Highway Patrolman Frank Fenlon, who saw it at 6:10 a.m. at his San Carlos home:

"At first there was a brilliant light, like a star. It was surrounded by a white cloud, sort of like the ring that is around the moon some times. The whole thing was moving together in a northerly direction, toward the moon.

"It continued more or less in a horizontal plane for a minute or so until there was an explosion and black puff of smoke. Then it continued on, but seemed to be going up higher. It climbed for 30 seconds or so.

"Then there was a white puff of smoke. I guess that was the third stage. Then the smoke disappeared and it started climbing—like a bright star. I shielded my eyes from the full moon with my hand and followed the object until it rose out of sight."

Twenty minutes later the contrail still hung in the sky, twisted by the lofty winds into a giant serpentine cloud, tinted pink by the rising sun.

The Boston University Telescope



The Boston University telescope was a large telescope used by the Air Force Eastern Test Range (AFETR) to monitor rocket launches from Cape Canaveral. It had a 24-inch mirror and 240-inch focal length, which was mounted on a 4 wheel carriage designed to mount a 90mm cannon. The 240-inch focal length (6000 mm) could be increased with a series of barlow lenses up to 2400 inches (60000mm). Operators, using 40X spotting scopes, would operate hand wheels to slew the carriage in azimuth and elevation in order to maintain the rocket in the field of view of the main telescope.¹

Location... Location....

In August 1964, the BU telescope was used from a position on the California coast to monitor a series of launches from Vandenberg AFB. The location chosen was at a peak somewhere along the ridge line at Big Sur but the exact location is something of a mystery. Robert Jacobs stated it was off US-1 near Anderson Peak.² Kingston George would give a similar location.³ The actual location is identified in the Operational analysis for the Image Orthicon project as being along Partington Ridge at 121 deg 41' 36" west longitude and 36 deg 12' 40" north latitude.⁴ Plotting this on Google earth shows that location to be on the wrong side of the ridge for views to the southwest (see IOBUTelescopeLocation at left). This may have been a case of a transcription error and the actual location might have been 121 degree 41' 37" west and 36 deg 12' 36" north, which appears to match the description in the report (see BUtelescope1 location at left).

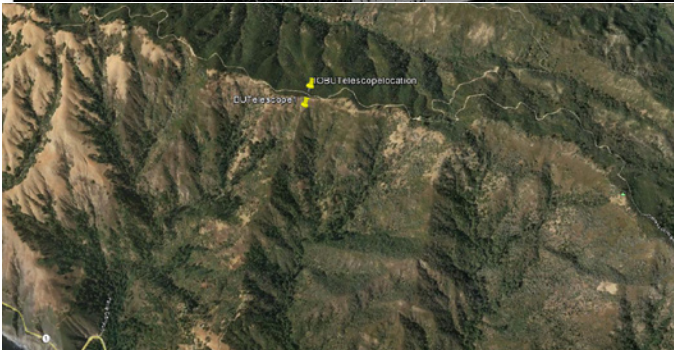

These photographs supplied by Kingston George shows the BU telescope crew on top of a wooded ridge similar to those seen in the location identified using Google Earth.⁵ From Partington ridge, at an altitude of 3400 feet, the BU telescope had a clear and unobstructed view of the horizon.

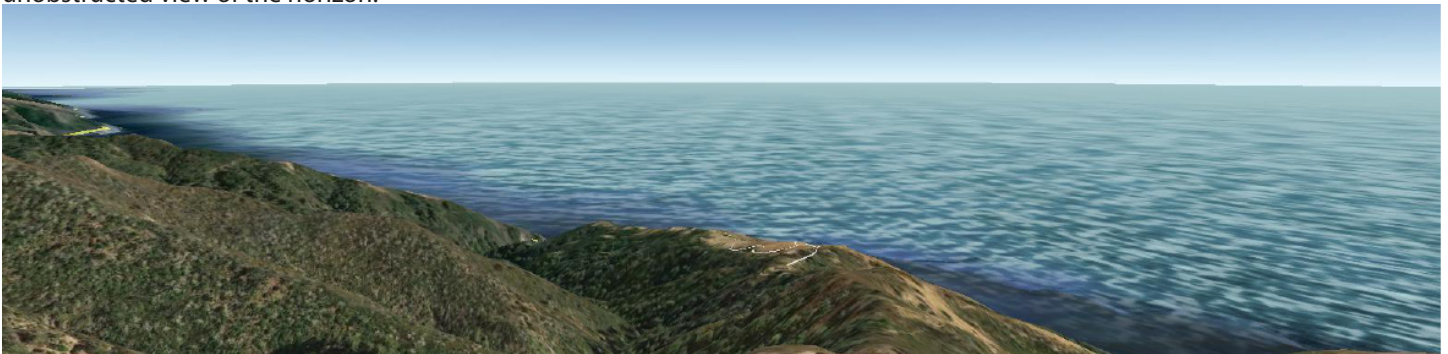

A question of resolution

The recording of the rocket launches with the B. U. telescope was a bit different than simply attaching a motion picture camera to the telescope. Instead, an image orthicon tube, designed for use in low light conditions, was used at the scope's focus. The signal from this tube was then fed, via Coaxial cable, to a monitor into a van. The operator would observe the monitor and adjust the gain of the tube and monitor as necessary to obtain the best images. A 35mm Mitchell motion picture camera was then used to film the monitor display (see image to right).⁶

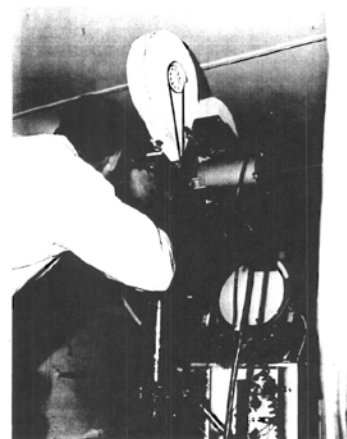

This kind of recording system is similar to the old Kinescope recordings used in television before the days of video tape. Kinescope was considered so poor that the Desilu productions refused to use it in their "I love Lucy" broadcasts. Video recording engineer Frederick Remley would write the following about the Kinescope recordings:

*Because of the many variables in the combined electronic/photographic process, the quality of such recordings often leaves much to be desired. Defects often encountered in photographic recording include relatively poor image resolution; a compressed brightness range often limited by kinescope display technology to a brightness ratio of about 40:1; nonlinearity of recordings, as exemplified by lack of gradation in both the near-white and near-black portions of the reproduced pictures; and excessive image noise due to film grain and video processing artifacts. The final signal-to-noise ratio is often less than 40 dB, especially in the case of 16 mm film.*⁷

One can see the difference between kinescope recordings and video tape recordings in this YouTube video (see still images from the video below).⁸ After examining this video, it is apparent that the Kinescope system was inferior and caused some loss in resolution.



Despite this known problem, it really was the only system the B.U. team could use because the video tape systems at the time did not have the necessary bandwidth.⁹

This problem with the quality of the film recordings not duplicating what was seen on the monitor was mentioned in the final report for the Image Orthicon project:

*The 500 to 1000 lines on an advanced TV system should not in theory be seriously degraded by copying on such film. However, during the demonstration a loss of detail on the film compared to direct viewing of the monitor was experienced, so handling, processing and exposure techniques need further investigation.*¹⁰

One of the reasons that there was a loss of quality was because they did not use the full resolution of 875 lines in their filming of the images on the monitor because of technical limitations.

*The B. U. telescope system uses a fixed 60-cycle vertical sweep with an interlaced 875 line scanning system, each half-scan taking 1/60 second. The motion picture camera actually photographs only one half-scan on the monitor screen, or about 440 lines, as it has been found that the full double scan decreases the resolution on film due to distortion of the electric field on the target between lines on the first scan.*¹¹

To add to this resolution issue, the image orthicon tube introduced its own problems. Using an Image Orthicon tube with a 12-inch telescope in the early 1960s, Dr. J. A. Hynek and Justus R. Dunlap noted that their resultant photographs did not quite compare to conventional astronomical photographs when it came to resolving small details:

*As yet, the image orthicon has little to offer in high-resolution celestial photography of star clusters and galaxies. The necessity to enlarge the original optical image by projection causes a drastic intensity loss that is barely compensated by the speed of the image orthicon.*¹²

While Hynek and Dunlap were working with low light conditions, they were not exposed to another problem with the Image Orthicon tube when bright point sources were being recorded. Bright sources of light tended to overload the system and produce dark haloes around them. This effect was called “blooming”. Kingston George noted that “blooming” did occur in the films obtained by the B. U. telescope and that other effects were observed:

*The brightest ones would bloom on the closed-circuit TV monitor to form a blob, with size related to brightness, and also leave a persistent trail behind as the telescope panned across it. The tracking operators used hand wheels to constantly make tiny adjustments, and the TV screen resembled a pool of vigorous tadpoles.*¹³

One must remember that the purpose of using the Image Orthicon was for recording the events under low light conditions and not exactly for high quality images that could record minute details. Many of the claims about how the B. U. telescope was capable of recording such details are based on mathematical computations that assume ideal conditions. What has been ignored is that the method of recording these events introduced all sorts of issues that reduced the quality of the film.

Despite the limitations of this recording system, the B. U. telescope did prove that it could record enough during the missile’s flight to be useful. It was capable of identifying the major sequence of events and any deviations from normal operations. It could also track the vehicle, under the right conditions, for long distances.

How large would the rocket appear?

In his letters to various researchers, Florenz Mansmann made the claim that the B. U. telescope could photograph “nuts and bolts” from a distance of 70 miles. This kind of resolution appears to be exaggerated. According to the Image Orthicon final report,

*An Atlas missile at a range of 100 nautical miles subtends an angle of about 28 seconds of arc. At 720 inches focal length the length of the missile is portrayed by about 34 lines on a 440 -line TV system. On a ten inch high monitor screen, the image should be about 3/4” long.*¹⁴

100 nautical miles (115 miles) is about the distance Buzzing Bee was from Big Sur when BECO occurred.

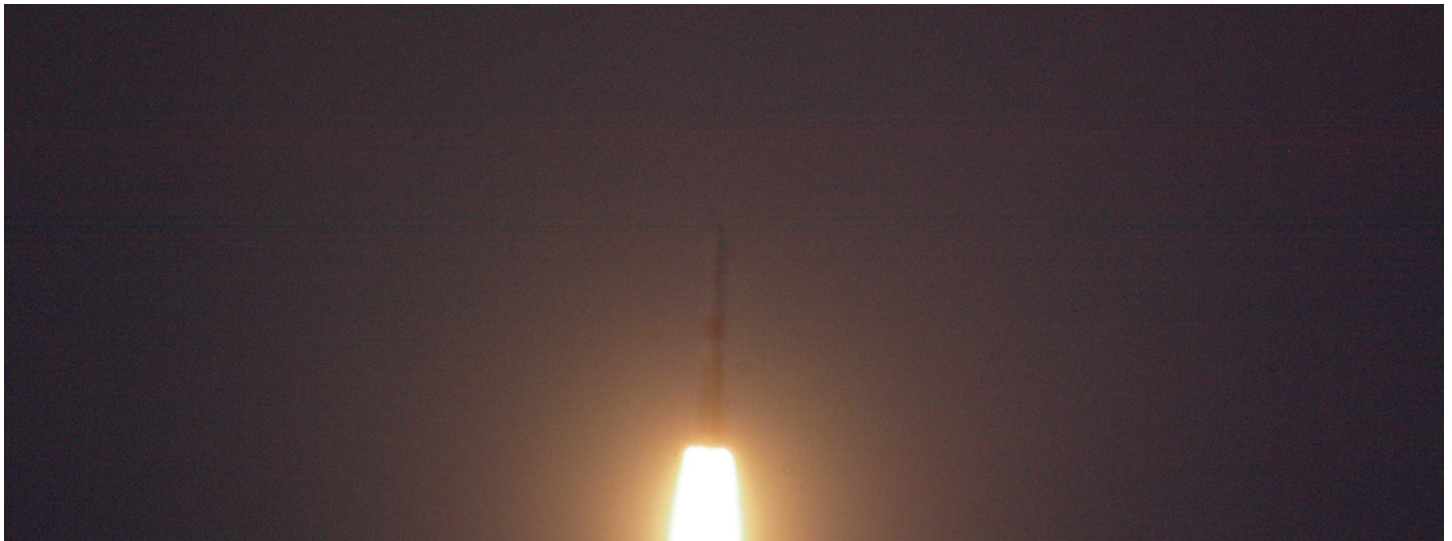

I recently photographed a rocket launch from the Cape of a Delta 4 rocket from a distance of about 9 miles. Using an 800mm lens (32 inch focal length) and a Pentax K110D (6 MP Digital SLR) I took this photograph of the rocket shortly after liftoff. While it is not a duplicate of what one expect of the Image Orthicon imagery, it does show the kind of scale one might expect from the BU telescope in the early part of the launch. The Delta rocket was 2.5 times the size of the Atlas Missile, which means that the Atlas missile would appear the same size using a telephoto with a focal length of 80-inches. Since the B. U. Telescope was a 720-inch focal length, then the distance to achieve the same size for an Atlas missile would have been about 80 miles. This is less than the distance from the Big Sur location to Vandenberg (over 100 miles). In my opinion, something like this image is the best one might expect in the imagery from the B.U. telescope. While the rocket would have been large enough to see, one can hardly call this “nuts and bolts” imaging as Florenz Mansmann described it.

This observation appears to be confirmed by what the Image Orthicon project final report states:

*It was pointed out above that certain lighting conditions must be satisfied to result in photography of the missile body; however, when those conditions are met, an advanced image orthicon system will operate with sufficient resolution, at the distances employed in this test period, to provide useful engineering data. Missile roll, unusual engine deflections, and structural failures should be readily observable on the screen with an image an inch or longer in length portrayed by 50 to 100 lines.*¹⁵

While it states that certain failures can be observed, all of those listed are large parts of the missile and not small items like “nuts and bolts”.

The implications are that if seeing fine details at 70-100 miles was difficult, seeing them at over 400 miles, when the RV was deployed, would have been very unlikely. This is essentially what Kingston George stated in 2009:

*With a deep bow to the fabulous sequential-scanning color HDTV systems of today, our primitive IO setup of 1964 would **not** have produced something with a distinct shape. The film was a collection of energetic blobs in black-and-white that only made sense when the launch exercise was understood in detail.*¹⁶

Based on this information, it appears that the claims of seeing fine details on the film, even when using a magnifying glass, are highly exaggerated. If there were a craft orbiting the RV during the launch, it would have appeared not much more than a blob of light on the film. Anybody trying to examine such an image would see what they desired to see.

Notes and references

1. George. Kingston A. Preliminary Report on Image Orthicon Photography from Big Sur. Headquarters 1st Strategic Aerospace Division, Operations Analysis Staff Study, 13 October 1964. P. 6.
2. Jacobs, Bob. "Deliberate Deception: The Big Sur UFO filming". MUFON UFO Journal, No. 249, January 1989. P. 4.
3. George. Kingston A. "Buzzing Bee mythology flies again". Skeptical Inquirer. January/February 2009. P. 43.
4. George. Kingston A. Operational Analysis Image Orthicon Demonstration Project. Headquarters 1st Strategic Aerospace Division, Operations Analysis Staff Study, 1965. P. 29.
5. George, Kingston E-mail to James Oberg July 2003.
6. George. Kingston A. Operational Analysis Image Orthicon Demonstration Project. Headquarters 1st Strategic Aerospace Division, Operations Analysis Staff Study, 1965. P. 11.
7. Wikipedia. Kinescope. Available WWW: <http://en.wikipedia.org/wiki/Kinescope>
8. Australian television archive research and supply services. Kinescope Versus Original Video - Demonstration/Comparison Available WWW: https://www.youtube.com/watch?v=Jig_YmB-KGg
9. George. Kingston A. Operational Analysis Image Orthicon Demonstration Project. Headquarters 1st Strategic Aerospace Division, Operations Analysis Staff Study, 1965. P. 51.
10. *ibid.* P. 44-5
11. *ibid.* P. 49.
12. Hynek, J.A. and Justus Dunlap. "Image orthicon astronomy". Sky and Telescope. Cambridge, MA. September 1964. P. 129.
13. George. Kingston A. "The Big Sur 'UFO': An Identified Flying Object". Skeptical Inquirer. Winter 1993. P. 181.
14. George. Kingston A. Operational Analysis Image Orthicon Demonstration Project. Headquarters 1st Strategic Aerospace Division, Operations Analysis Staff Study, 1965. P. 42.
15. *ibid.* P. 42.
16. George. Kingston A. "Buzzing Bee mythology flies again". Skeptical Inquirer. January/February 2009. P. 45.

The documented record for Butterfly Net and Buzzing Bee

The official version of events regarding Buzzing Bee and Butterfly net was documented in several classified reports describing how well they were tracked by the B.U. telescope and the radar systems at Kwajalein. Assuming they are an accurate record of what happened, they resolve the question of which versions of events is more accurate.

Butterfly Net - September 15, 1964

According to the final report written by Kingston George in 1964/1965, the launch of Butterfly Net was not well recorded:

Butterfly Net was launched on a day that was slightly more hazy than average; however, the missile was tracked by the B.U. telescope and the 180-inch lens operated by the 1369th Photo Squadron. The smaller image orthicon system and the 360-inch camera photographed a large part of the flight, but the operators lost track before SECO on both instruments. The missile body is barely visible in the films obtained with the 180-inch camera around the time of BECO, demonstrating the "ordinary" focal length photography shows much promise from the Big Sur location. Black and white film was used in this camera, and the booster engine staging sequence is remarkably clear and interesting, comparable in quality to the image orthicon photography of BECO on "Buzzing Bee".

The B.U. telescope films of "Butterfly Net" are not of as good quality as those of "Buzzing Bee", partly because the kinescope was slightly too dark for registering dimly illuminated objects on the camera film. Another problem was that the sky was turning bright in the west at the time of launch, 94 minutes after sunrise, and the contrast between sun-reflecting objects and surrounding sky decreases rapidly some 45 minutes after sunrise. The combined effects of slight haze, technical problems, and poor sky contrast precluded the sighting of objects at the end of powered flight.¹

It is hard to reconcile this description of the film with the description by Jacobs, who proclaimed that images of the re-entry vehicle/warhead deployment were very clear. There is also no mention of any anomaly in the flight trajectory that caused the warhead/RV to go off course and crash into the ocean. This is confirmed by the Nike-X Weapons report of September 1964:

On September 16 at Kwajalein the Nike-X elements gathered data in successful observations of a Low Observable Re-entry Vehicle (LORV) designated LORV-L3. The target complex, launched from Vandenberg Air Force Base by an Atlas D rocket, contained the LORV-L3 re-entry vehicle, a graphite test vehicle, and a scientific passenger pod containing instrumentation to monitor the Atlas booster operation.

...The Discrimination Radar, operating under single computer control, in the fine frequency mode, acquired the target complex from ZAR data. The scientific passenger pod and re-entry vehicle were observed at a range of approximately 700 nautical miles. A track was established on the re-entry vehicle and maintained for 115 seconds, down to an altitude of 21 nautical miles. The graphite test vehicle and an unidentified object was observed late in the mission. Object placement was close to nominal. Starting at about 450 nautical miles, the DR made several designations to TTR4 until the latter established solid lock on at 147 nautical miles.²

The rest of the report describes how the other radar systems were able to track the re-entry vehicle to the designated target area. The airborne aircraft appeared to be capable of tracking the targets with its optical systems as well:

The EC-121K optical/IR instrumented aircraft with its ground designation system, gathered data on the graphite test vehicle and the tank. The re-entry vehicle did not appear to glow.³

The report gives no mention of any unknown vehicle interfering with the re-entry vehicle or any other payload on radar or optically. By all accounts, "Butterfly Net's" rocket and payload performed as planned and the launch was a big success.

Buzzing Bee - September 22, 1964

At the time of its writing, the final report on the project was classified CONFIDENTIAL and eight frames from this film were included. We don't have an exact date when the report was written but it appears to have been written several months after the event and, by that time, the film may have been downgraded to CONFIDENTIAL (as George stated in his original article) once it had been analyzed. According to that report, everything from BECO to RV deployment was filmed with the B. U. Telescope:

All these events were captured on film, and the bright points of light. as the objects appear on film at these ranges, were photographed out to about 650 miles from the Big Sur site. For a short period after BECO, the entire missile is visible on the projected films. Decoy pod cover removal was detected at approximately 160 seconds.

Photographs 11 through 18 are single frame negative reverse enlargements (for extra contrast) of the "Buzzing Bee" film. In photograph 18, the six objects in the lower left that are in a circular arrangement include two decoys and four Styrofoam spacers from the decoy tubes. From discussions with personnel in the 6595th ATW, we understand that these spacers or blocks were supposed to remain fastened to the sustainer stage after decoy deployment, and the B. U. telescope films were taken as evidence that the tethering system failed in some fashion.⁴

I expect that the quality of the images were better than those reproduced here and in the report, but they do demonstrate the quality of the images that the B.U. telescope was capable of. The upper left object is an azimuth/elevation indication. The T+320 seconds image is very revealing. In that image, one can see the decoys, the booster stage, and the RV. Joel Carpenter felt the bright spot below the rocket body might be HIRS plume but I suspect it may have been a bright spot introduced by the Image Orthicon tube or an effect produced by filming off the monitor. The T+380 second image shows, what appears to be, the RV and decoy warheads. No UFO appears in these images.

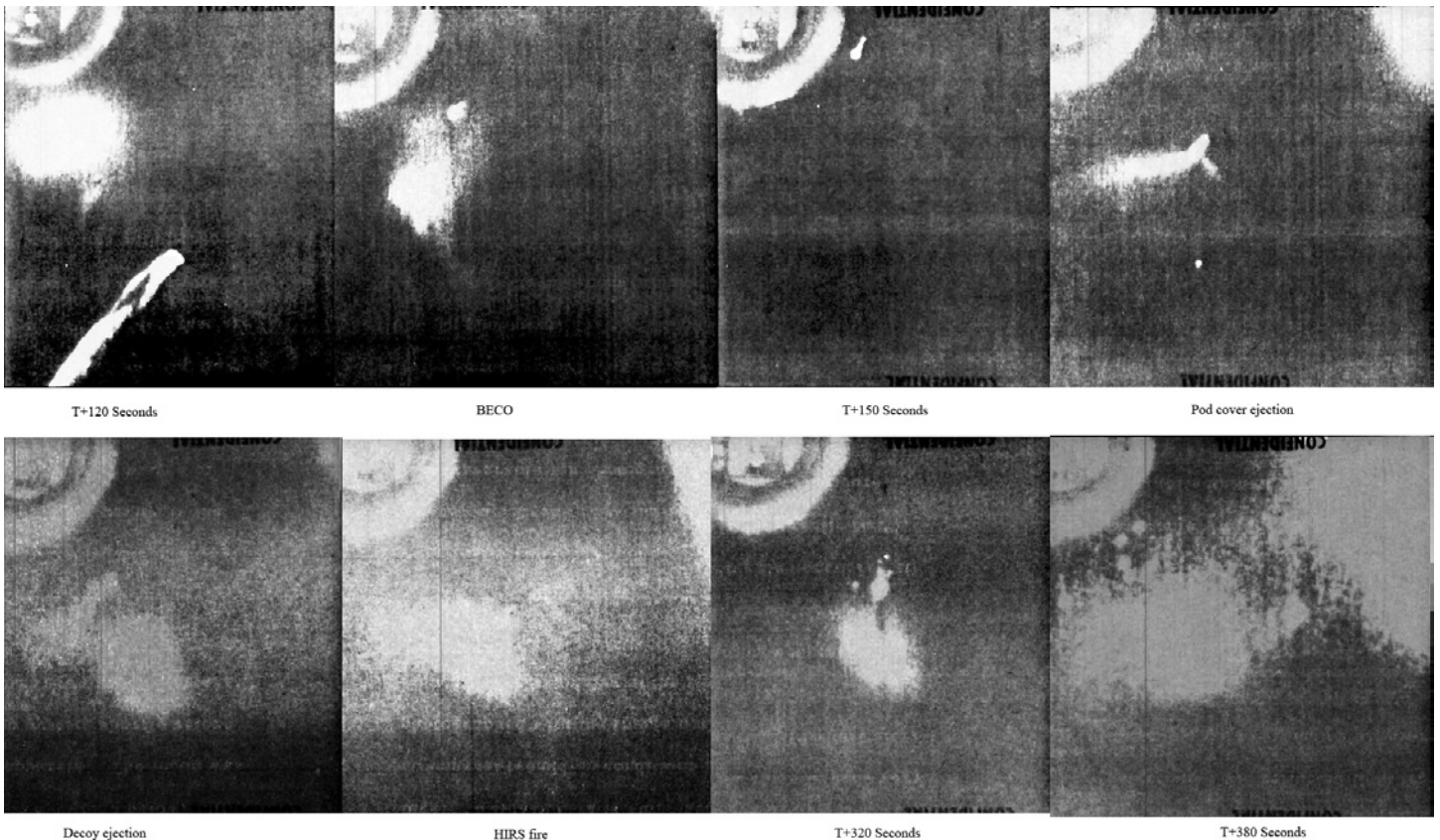

Meanwhile, at Kwajalein, the Nike-Zeus radars were capable of tracking the incoming targets:

On September 23, the Kwajalein Nike -X equipment participated in successful observations of an Atlas ICBM mission designated KX-19. This was the most successful mission to date, with all test objectives being achieved.

The target, launched from Vandenberg Air Force Base in California, was boosted into the Kwajalein area by an Atlas D rocket. The target complex consisted of a modified series-30 TVX and two radar decoys. Translation of the tank was provided. The flight time of the target was 35 seconds less than anticipated.

The DR operated under single computer control. The fine frequency mode was controlled to start 15 seconds before the target reached 400,000 feet altitude. The ZAR designation on the tank was received at 760 nautical miles, at which time the tank return was observed. Track on the re-entry vehicle was established at a range of 189 nautical miles and an altitude of 480,000 feet. This track was held until splash at 37 nautical miles range.

The DR also made a number of other observations starting with its receipt of tank track designation from the ZAR. A track on a decoy was established at a range of 64 nautical miles and an altitude of 97,000 feet and held until 10 nautical miles and 2300 feet. Another track, on a decoy or fragment, was held for 34 seconds, from 200 nautical miles to 87 nautical miles. Three centroid assignments were made to update coast data on the re-entry vehicle.⁵

The report mentions the optical instruments doing a reasonably good job of tracking the re-entry vehicle and other targets for several seconds. The ground base radiometer was able to pick up the target at a distance of 330 nautical miles on one channel.

As with the "Butterfly Net" launch, the payload successfully managed to make it to the target area without interference from an unknown vehicle and the radars did not report any unusual craft following the RV, decoys, or missile.

Notes and references

1. George. Kingston A. Operational Analysis Image Orthicon Demonstration Project. Headquarters 1st Strategic Aerospace Division, Operations Analysis Staff Study, 1965. P. 25-6.
2. Bell laboratories. Progress report for September 1964: Nike-X weapons system. Bell Laboratories. September 1964. P. 46-7
3. *ibid.* P. 47
4. George. Kingston A. Operational Analysis Image Orthicon Demonstration Project. Headquarters 1st Strategic Aerospace Division, Operations Analysis Staff Study, 1965. P. 20-1.
5. Bell laboratories. Progress report for September 1964: Nike-X weapons system. Bell Laboratories. September 1964. P. 47-8.

UFO, misidentification, or hoax?

After examining all the documentation available we can now make some observations about the claims made by those who were present and see which individuals were more accurate in describing the actual events.

Butterfly Net and Robert Jacobs' recollections

The reports indicate that Jacobs' recollections of this event are inaccurate. Specifically:

1. The LORV was not "shot down" at all and successfully made it to the Kwajalein target area just as the USAF public affairs sergeant told Eric Mishara of Omni, which Jacobs referred to as a lie.
2. There is no mention of a "radar chaff cloud" being used in this launch in either report. If there was a radar chaff cloud deployed, the Nike X report would have mentioned its role in interfering with the tracking of the target from Kwajalein.
3. The B.U. telescope lost the rocket at the end of powered flight, which is before the LORV was released. There was no filming of the missile's flight when the UFO supposedly interfered with the LORV's flight.
4. The B.U. telescope had difficulty in resolving details because of haze and the bright sky interfering with the operation of the IO setup.

The only thing Jacobs might be able to pin his hopes on were the mention of the Discriminating Radar tracking an "unidentified object" with the graphite test vehicle in the Nike-X report. When I asked Joel Carpenter about this, he felt it was probably the scientific pod, which was used to gather data on the Atlas booster performance. That might be or it may have just been some sort of debris from the rocket that was tracking along with the payload. This was all well after the payload had left the visibility of the BU telescope and can not be considered evidence that Jacobs' story is accurate. With so many errors in his recollections, it is hard to consider Jacobs' story credible.

Buzzing Bee and Kingston George's recollections

On the other hand, Kingston George's recollections about what was on the Buzzing Bee film were pretty accurate. There seems to be no reason to question his claims that there was some concern for security because of what the film revealed about the decoy deployment. According to Carpenter, he had contacted Kingston George with a copy of the report. George was surprised to see it and remarked that he had thought it, like the film, had been destroyed. The sketch he made over ten years ago, of the re-entry vehicle, the rocket tank, and decoys¹, is a close approximation of what is shown in the T+320 seconds image (labeling of T+320 second image done by Joel Carpenter).²

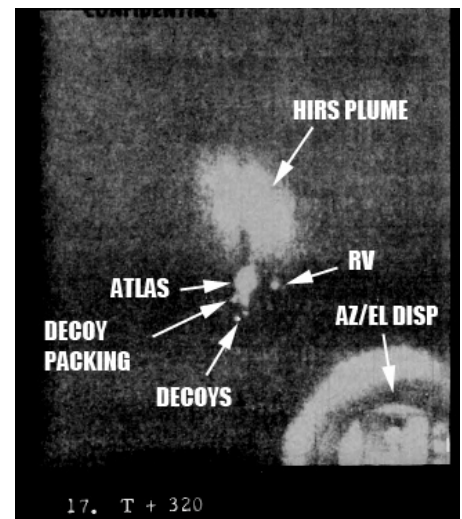
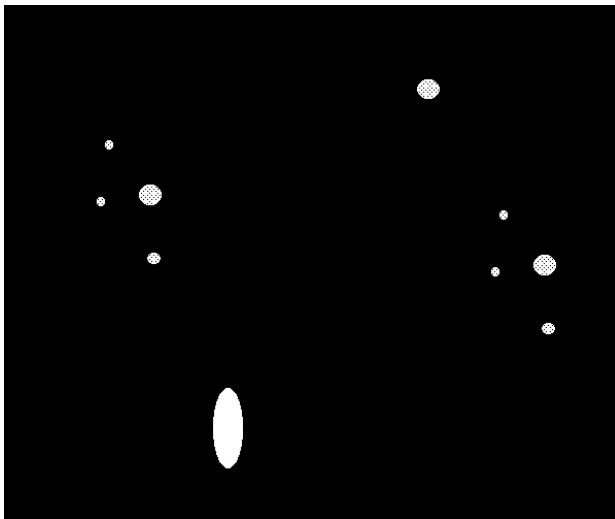

What about the "energy beams"

The mention of "energy beams" by Jacobs may have been due to the operation of the HIRS after RV deployment. Joel Carpenter felt that the retro rockets on Buzzing Bee would have created momentary bright flashes on the film and may have been interpreted as "energy beams" being directed towards the RV. Of course, the flashes of light could easily have been issues associated with the operation of Image Orthicon tube as Kingston George suggested. In either case, there seems to be reason to believe that there is a logical explanation for Mansmann and Jacobs thinking they had seen energy beams being fired from a UFO toward the re-entry vehicle.

Misidentification/confused memory

There are several items that I believe are factors associated with this case that have been ignored in all the previous articles written about this case:

- The widespread UFO reports made during the Buzzing Bee launch.
- A launch involving a Minuteman missile on September 29th (the last launch filmed as part of the IO project) malfunctioned while the telescope was tracking it. Kingston George describes the event in the final report:

"Painted Warrior" was launched about 190 minute after sunrise, and was tracked by the B. U. system throughout powered flight. The gyrations of the third stage following a malfunction at the end of second stage burn are clearly visible on the films, and the stage was lost to view of the trackers when the flame disappeared, apparently due to propellant exhaustion.³

This was the only malfunction that had occurred in all the flights and is the malfunction mentioned in the preliminary report that Jacobs thought applied to the "Butterfly Net" launch. Despite this malfunction, the payload still appears to have been delivered to the target according to the Astronautix web site.

- Jacobs emphasized in interviews that the missile he recalled deployed radar chaff. No such payload was used in the "Butterfly Net" test. However, Buzzing Bee did have decoys deployed and their associated debris that might be interpreted as "radar chaff". This is an indication that Jacobs' memories of the actual film he saw was the flight of "Buzzing Bee" and not "Butterfly Net" as Kingston George hypothesized twenty years ago.
- The main source of the event involving an alien spaceship (AKA UFO) are the memories of two men. There is no documentation to support their claims and it is very possible that the details they describe are from a false memory. Dr. Elizabeth Loftus, in her book, "Eyewitness testimony", describes how memories can be compromised by many factors:

During the time between an event and a witness's recollection of that event -- a period often called the "retention interval" -- the bits and pieces of information that were acquired through perception do not passively reside in memory waiting to be pulled out like fish from water. Rather, they are subject to numerous influences. External information provided from the outside can intrude into the witness's memory, as can his own thoughts, and both can cause dramatic changes in his recollections.

People's memories are fragile things. It is important to realize how easily information can be introduced into memory, to understand why this happens, and to avoid it when it is undesirable.⁴

It seems perfectly reasonable to suspect that the combination of UFO reports filed from the Buzzing Bee launch, the concern about security associated with the Buzzing Bee film, and the malfunction recorded in the "Painted Warrior" Minuteman film could have been combined together by Jacobs, influenced by his belief in alien visitation and conspiracies, to create a story about a UFO that had shot down an ICBM. After that story was published, Florenz Mansmann, who trusted Jacobs, accepted this as an accurate recollection of events and added additional details that he recalled. Unfortunately, their strong convictions that they were accurately recalling these events has persuaded many that this was excellent evidence of aliens interfering with human activities. We now know that the documented record states that these two individuals were mistaken about what they recalled and there never was any UFO event.

Conclusion

Based on the documentation provided to me by Joel Carpenter, there seems to be little doubt that the events filmed by the B. U. telescope did not involve an alien spaceship trying to shoot down a rocket/warhead/re-entry vehicle. Despite these revelations, I do not believe that there will ever be enough evidence to explain, to everyone's satisfaction, that no UFO was involved. Some individuals have already invested too much of their reputation in defending it and can not accept any possibility other than an alien spaceship. However, for people interested in examining the actual documented evidence, there should be enough information to consider this case to be closed. Unless new evidence surfaces to refute these documents, the rest of us can accept Joel Carpenter's assessment that the case is "another one for the Retired UFO Yarn Hall of Fame".

Notes and references

1. George, Kingston E-mail to James Oberg July 2003.
2. George, Kingston A. Operational Analysis Image Orthicon Demonstration Project. Headquarters 1st Strategic Aerospace Division, Operations Analysis Staff Study, 1965. P. 23.
3. *ibid.* P. 26.
4. Loftus, Elizabeth F. Eyewitness Testimony. Cambridge, Massachusetts: Harvard University Press. 1979. P. 86-7.

In an effort to make all the documentation available, I have placed the pertinent documents on my website for download. The links are:

<http://www.astronomyufo.com/UFO/IOPROJREPORT.pdf>

http://www.astronomyufo.com/UFO/Big_Sur_Nike_Report.pdf

BREEDING HISTORY

by
Martin S. Kottmeyer

"There is a program of breeding analysis."

This line in the regression transcript of the Herbert Schirmer alien encounter of 1967 has become a point of focus about the case. It grew in significance as abductions became one of the public faces of the ufo controversy. Budd Hopkins in 1987 would famously conclude in *Intruders* that *"an ongoing and systematic breeding experiment must be considered one of the central purposes of ufo abductions"* (Hopkins 1987) In *Secret Life*, David Jacobs elevates the idea to a defining trait of abduction studies and calls the alien's activities The Breeding Program in a chapter head. When ufo historians look back on the Schirmer case they point to this line and say things like, *"This is the first overt reference in an abduction case to a genetic program conducted by aliens, although there were strong hints in the Villas Boas and Hill cases."* (Brookesmith 1995; 1998)

Jenny Randles would offer this provocative comment on the Schirmer revelation,

They referred to the fact that they had a breeding analysis program underway, but did not elaborate. This seemed to have been connected with human samples they were taking and is another early reference to the genetic experimentation program which came to dominate later cases. In 1967 we were still struggling to make sense of the human genetic code." (Randles 1993)

The line sometimes seems to be the only thing a modern ufo maven will even find interesting about the Schirmer case. It is amusing to note, however, that you will not find the line anywhere in the chapter on Schirmer's case in the work that gave it the widest popularity, Ralph and Judy Blum's *Beyond Earth*. It is all the more surprising when you realize that the Blums' account is commendably informative and leaves out virtually nothing else of relevance in forming a judgment about how credible Schirmer's story does or doesn't sound. In the 1970s, the most popular theory on alien intentions was that aliens were conducting surveillance and studying Earth and the Blums picked out everything that reinforced that theory. The breeding line didn't really fit in with that idea and I would not be surprised if the word grated on their sensibilities as almost taboo.

Breeding.

In its most disturbing aspect it implies sex without free choice. Someone has decided this animal will be mated with that animal because he wants a particular type of outcome: a faster horse, a cow that gives more milk, a prettier cat, a more useful dog. That's fine for animals, but breeding humans is a different matter. This is not to deny some have thought it a good idea. The Nazi's did. They had fantasies about creating breeding colonies to create a Master race.(Hermand 1992) One anthropologist proposed using the diluted semen of a few perfect specimens and artificially inseminating many women to improve the human race. (Hecht 2000) Cut straight to the trouble: Who decides? The people who end up in the position of power invariably seem to be the sort who shouldn't be doing the deciding. Yet the people who initially espoused eugenics did have a certain amount of high-minded virtue in mind. At the turn of the century, intellectuals felt that the human race was rapidly degenerating. With medicine giving the feeble a chance to live and reproduce, the world would be over-run by urban rabble and the gene pool would start filling with the 'unfit.' That was the logic anyways.

All the same, others knew there would be evil in this. Hollywood saw the dramatic potential quickly and turned out a series of films on lovers prevented from marrying because eugenics committees decided against the union. (Pernick 1996) One unique entry in this genre was the first science fiction musical *Just Imagine* (1930) wherein a man schemes to marry his personal choice by proving to a eugenics council his fitness by becoming the first man to explore Mars. Another evil came from the practice of involuntary sterilization.

Science Fiction cultivates an attitude of estrangement from normality that is one of its defining features.(Suvin 1976, 1979, 1988) It was perhaps inevitable that the notion of breeding humans quickly found its way into its pages. One early pulp story that bears some interest involves a race of short, bald and brainy beings, a product of accelerated evolution that hid away in the earth's interior. We would certainly term them Grays nowadays. A scientist learns this race has been procuring humans from the surface for a number of years. Some are used as slaves, a few extinct varieties are preserved in zoological gardens, others become scientific specimens:

These people are always performing experiments with disease and germs. They perform them on human beings, men and women alike...open their bodies and study them and then throw them away...They take women and breed them for experimental purposes. (Keller 1930, p. 733)

This vivisectional context would be emphasized by Meurger (1996). Later, the story's scientist narrator hears one of these proto-Grays tell him,

For centuries, we have been trying biological experiments to make a new race of workers. I suppose we have used five thousand women of different nationalities in these experiments. At present there are 300 white females in our biological laboratories. Naturally, they would rather die than return to their families. (Keller, p. 734)

Another story that foreshadows modern ufo mythology is "The Thunderer." A mad eugenicist plans to run the world like a stud farm

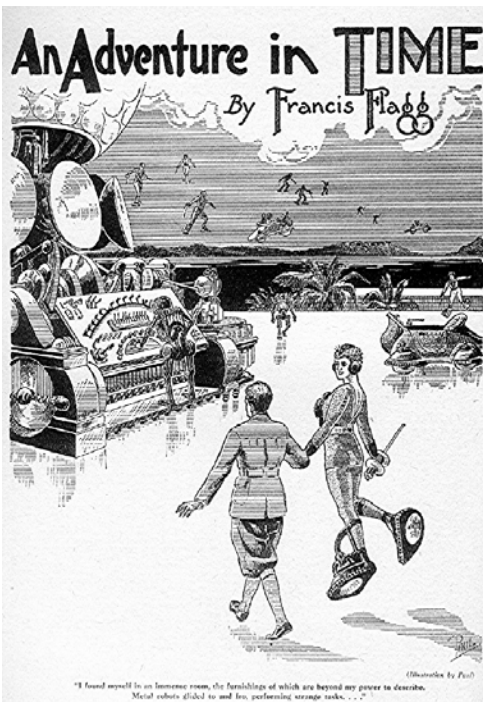

and oversee things from the titular airship. His scientific powers include an ability to control the weather and a ray that short circuits the engines of any plane that tries to approach his aerial fortress. (Johnson 1930)

There is also Francis Flagg's 1930 tale "An Adventure in Time." A man time travels to California a millennium hence and finds a matriarchal utopia where war has been banned, mechanicals have taken over all work, and people walk on air. The women are all tall and statuesque, but the men are all less than five feet. The women teach that the male-dominated past was a horror and use reproductive science to keep their numbers a minority too small to acquire voting leverage. A man explains,

By a process of breeding combined with some secrets they have learned in handling embryos in the incubators the Mothers have stunted our growth while augmenting that of their daughters. Yes, he cried, they have given us these pigmy bodies, all of a size, while endowing women with magnificent physiques.

Some women are suggesting the brains should be stunted as well leaving men only what is necessary to eat and mate. The time traveler is enlisted to assist their rebellion since he is tall enough to pass as a woman in places of power, but it quickly fails when he becomes distracted by a woman he recognizes. He becomes her prisoner and fortunately her taste in men prefers they not be puny. Though the time traveler was once a wrestler, she overpowers him. He is only able to stop her advances with a trick involving a nerve pinch. When she submits, he falls irresistibly in love with her Amazonian beauty and a romance ensues.

He witnesses 12 giant cigar-shaped airships under her command. They intervene in a war among primitives by melting all weapons with a special ray. The couple ends up in the secret city that is home to the ecto-genetic laboratories. She undergoes a ceremony that allows her to join the Hierarchy of Mothers. Their love is consummated, she bears his seed, but then her brain is de-memorized and electro-hypnotically her passion for him is gone. He is told their season of love is over and he is to be sent to the House of Husbands. He is immediately put under the mesmeric control of a machine. He sees strange instruments and something like a giant X-ray machine and then he falls unconscious. He awakes and finds himself bearing a large tattoo etched with his lover's name and the brand VIRSEKSO 1426X. In horror, he returns to the past with his warning of what came.

I have discussed elsewhere at length the significance of a remarkable John Campbell story "The Invaders" (1935) that tells the tale of an alien race that had an ambitious multi-generational eugenics program directing human evolution to a superior form that exhibits paranormal mind powers. (Kottmeyer 2007)

It is also amazing to note that the idea of aliens breeding humans turns up in the 1938 Orson Welles radio script of War of the Worlds! A survivor of the alien attack begins musing on their likely fate. Eventually they'll stop wholesale slaughter and start systematically catching and keeping the best, most tasty humans and storing us in cages.

"The Martians will be a godsend for those guys. Nice roomy cages, good food, careful breeding, no worries. After a week or so chasing about the fields on empty stomachs they'll come and be glad to be caught." (Cantril 1982/1940)

Conservatively, 6 million people heard it.

Hugo Gernsback, the father of the science fiction genre, wrote a novel in 1958-9 titled Ultimate World bearing many similarities to modern abduction mythology that involves a race of superior beings who have the familiar attitude of estrangement:

It became known soon from the various science reports that the superminds were probably breeding humans as we breed cattle. (Chapter 4)

The book was published in 1971, after his death in 1967. One can deny whether one could call this either a major or even innovative work. It is undeniably Gernsbackian, a thoroughly traditional pulp tale. Surprisingly the full text is available on the Web.

"Earth's Last Citadel" by C.L. Moore and Henry Kuttner has been hyped it as "unrivaled among fantasy classics" and features alien beings whose bodies have been sacrificed to the mind. When they came to Earth they exterminated most of humanity as vermin, but they kept some as pets... "the experimental races they bred and interbred." One character worries, "I'd never realized how alien the Aliens were until I heard about the things they made out of human flesh." Some were meant to be a slave race like they had on their home world, but they were unable to cut away the seeds of rebellion in the human mind. It kept growing back. One of their successes is a princess having the unearthly perfection of a delicate flower. She's described as "overbred, painstakingly cultured." (Kuttner & Moore 1950)

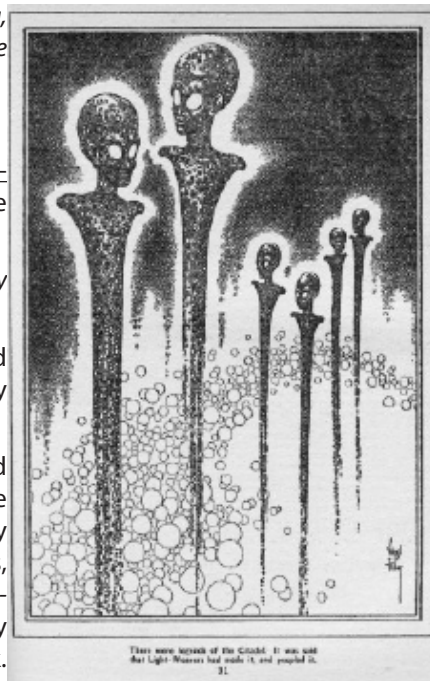

These were members of the Citadel. It was said the Light-Wearers had made it, and populated it. 31
Virgil Finlay's rendering of those breedin' fools, the Light-Wearers of "Earth's Last Citadel"

Another interesting exercise to expand and explore the alien attitude of humans as breeding stock appears in Rog Phillips' 1949 tale "Incompatible" A telepathic alien crashlands on earth and while mentally probing the inhabitants is puzzled to learn,

"It was the fantastic realization that these creatures were totally lacking in breed lines, genetically... They not only did not have semblance of breed affinity, but also they often did not realize individually what breed line was dominant in their structure."

This eventually prompts the notion in it,

"Perhaps-perhaps it might be possible to take over the direction of life on this planet and isolate the various breeds into true ones again."

Her own gene structure could lend our species strength though the thought of mating with something that was "less than cattle" made it shudder. Humans appeared to be "one breed - a horribly mixed-up mongrel breed." (Phillips 1949)

Anne McCaffrey, penned a short story for an SF contest, titled "Freedom of the Race" inspired both by her being pregnant and by H.G. Wells' War of the Worlds. Martian invaders use women as "brood mares" because their fragile wives could not give birth in the highly oxygenated air of Earth. A Martian doctor remarks of an earth woman about to deliver several Martian babies, "Such a healthy animal, an excellent breeder." However they get bad news, all the Martian babies are dead because she had been exposed to rubella, German measles. "Pregnant women's greatest fear was now their savior!" (McCaffrey 1953)

In the 1950s there are a number of alien invasion films that have sexually exploitative aspects; some imply hybridization, but little actual use of the word breeding. Invaders from Mars (1953) maybe deserves mention for a line asking "Could you disprove, for example, that the Martians have bred a race of synthetic humans to save themselves from extinction?" That hypothetical race is called mutants. The use of the word synthetic is perhaps analogous to hybridization, but this has a stronger association to manufacture and mutants suggests radiation was the modifying agent, not selective mating. It thus rings perhaps false to use this as a proper ancestor to the abduction myths.

This changes after 1964 due to an infamous scene in the brilliant Kubrick film Dr. Strangelove. A not-so-ex-Nazi in a wheelchair is discussing what we should do after the triggering of the Soviet doomsday device. He suggests the creation of an underground nucleus of survivors. People would be selected by a computer programmed to get a cross-section of necessary talents and highly stimulating females. The doctor rhapsodizes,

"Actually they would breed prodigiously, eh; there would be much time and little to do. With the proper breeding techniques and a ratio of 10 females to each male I would guess that they could then work their way back to the current Gross National product within, say, 20 years."

The 1964 skin flick Kiss Me Quick rather overtly transplants this into alien mythology. An alien named Sterilox visits one Dr. Breedlove who is building the perfect specimen, a woman who will do what a man tells her to. Sterilox specifically comes to earth to find this perfect specimen and bring her back "for breeding purposes."

The following year, the dreadful Frankenstein Meets the Space Monster (1965) appeared. In it alien masters tell their crew "... we are extinct as a race, unless of course we can find some good breeding stock and repopulate our planet." The faux Egyptian queen laments, "We have won the war, but we have no women. We have come to this planet for one purpose only, to acquire breeding stock to repopulate our planet." This line about breeding stock was singled out for use in trailers promoting the upcoming film. Far more people picked up this wild notion from the trailer than actually saw the film.

On November 24, 1966, an episode of Star Trek, "The Menagerie," featured a race of bald big-brained aliens who knock out a captain of the Enterprise, Christopher Pike, and try to pair him up with a woman they picked up some years earlier. A character asks, "Then you were captured as breeding stock?" The answer is Yes. Much more, they were "planning to breed a society of human slaves."

Far better, in 1967, a film called Five Million Miles to Earth (1967) appeared that was part of the famous British Quatermass series of film. It is also shown under the title Quatermass and the Pit. The film's central revelation is that insectoid Martians systematically abducted man-apes in Earth's distant past. The Martians "altered them by selective breeding, atomic surgery, techniques we can't guess" and brought the mutated form back to form a colony by proxy.

Ufologists began adopting the term almost immediately. In 1966, the Lorenzens used the Antonio Villas Boas seduction case as an excuse to start speculating,

"If an alien race bent on contact and possible colonization were to reconnoiter this planet, one of their prime tasks would be to learn if the two races could breed... The ideal situation would be for experimenters to pick their own female subject whose own ovulation period

Freedom of the race
A Short-Short by ANNE McCAFFREY

The larger pains were increasing. The dainty Martian doctor arrived and examined her briefly. He chuckled over at the Martian nurse in charge. Although she understood Martian, Jean's mind registered the conversation dimly, for the odd amnesia of birthing dulled her to everything. The next spasm contracted her womb. She breathed deeply, slowly, as she'd been taught, expanding abdominal muscles to give the womb more freedom. All her energy was concentrated on breathing and relaxing, but slowly the doctor's words reached her mind. "Such a healthy animal, an excellent breeder, I have high hopes that everything will go all right in this case. If so, I'll insist the commissioner use her again. It's against our policy, but we are desperate." "So," thought Jean in her semislumber, "that's what happened to the girls who didn't come back to the Centre. They died issuing life to these multiple monsters. They weren't set free. They were right and we wouldn't believe her. She must be dead, too." Again the Martian nurse ordered her to turn over, and Jean felt the cold metal of the fetoscope on her swollen abdomen. She tried unsuccessfully to breathe deeply as another contraction gripped her, and she wanted so to turn back to her side. It wouldn't matter what she wanted... she was just an animal incubator. There would be no narcotic case to this birth. There was too much danger of asphyxiating the Martian get whose lungs at birth were curiously delicate.

That was before the vogue of multiple births. The rare instances of multiple births to a Martian were always stillborn. It was the experiment of transplanting twin placentas into a Terran womb, resulting in successful birth of twins. After that, she had to see. With a little scientific help, twin placentas, quintuplets, of whichever sex desired were reluctantly borne by Terran girls.

In the midst of this mindless reminiscence, Jean felt an irresistible urge to lean down and she responded automatically. She heard around her sudden movements, excited brusque orders from the Martian nurse who had never left her side for four months. She was conscious of several more Martian voices now, and very bright lights. She opened her eyes wearily and saw she was in the delivery room, her head being pushed against a slab table. Beside her were the Martian parents of the get within her... their odd yellow wolf-eyes glowering in the dark.

Then she felt the hands of the Terran nurse on her, moving her to the delivery table. The girl at her head fumbled to catch her under the arms and was severely reprimanded by the nervous Martian doctor. "You'll burn slow if you harm her," he shouted in his high, whining voice.

"She'll be all right," the nurse replied, with unexpected firmness for a Terran answering a Martian. The nurse bent low and said softly in Jean's ear: "Don't worry, baby, everything will be all right—another batch of dead, deformed offspring for our eager Martian liberators."

Jean snapped alert despite the excruciating pain. The Terran nurse smiled. A grin, triumphant smile. "German measles," she whispered. "Eighty per cent of Earth women who catch the disease from their third to sixth month of pregnancy produce children with some defect or deformity, deaf mutes, mongolian idiotism, and blind. In the case of fragile, Martian offspring, the total is one hundred percent. There hasn't been a normal Martian baby born in six months."

Jean remembered six months ago, when she had a slight fever and flushing of the skin! It was too mild for the Martians to notice and over so quickly that she hadn't considered it! Pregnant women's greatest fear was now their savior! This was only the beginning. Terra would be free.

30 SCIENCE-FICTION

would be known beforehand, and proceed exactly as the strange UFO occupants apparently did with Villas Boas." (Lorenzen 1966)

In July 1967, their next paperback gave an encore recycling:

"The possibility that the Villas Boas affair was in actuality a breeding experiment is logical although not emotionally acceptable to most."

Also, two pages earlier, they suggest the small anthropoid entity types seen in some saucer landing cases are trained animals used for specific purposes:

"In a very advanced culture, animals, including the intelligent ones might be bred for their specific dominating qualities. Man is currently thinking of the day when the human race could be improved with specialized breeding techniques. Does this necessarily have to be a unique idea?"

I'm pretty sure Schirmer's line about analysis is precisely tailored by the 1966 version which speaks of learning about the possibilities to interbreed. But just to be thorough, there may be a small possibility that Schirmer could have seen the word breeding in an Otto Binder paperback. A subsection title has the phrase "EARTH BREEDING STATION" in capital letters enhancing its visibility.(Binder 1968, p. 34) It brings forward AVB and two tabloid alien rape tales – Jean Sheldon & Marlene Travers – then concludes

"It would seem to fit quite naturally into this book's theme - that the earth is a colony or a breeding ground originally established by space people."(p. 35)

The book also invents the phrase "UFO-breeders" on page 134 and like Quatermass backdates the program into the distant past when it starts speaking of "anthro-biological experiments of the spacemen in their ancient brain-breeding program on earth." (p. 127)

The point should need no further elaboration. The idea of aliens breeding humans was hardly new by the time Schirmer came along. Aliens, mentally superior beings, scientific madmen were directing the breeding of humans in the realm of our imaginations decades before it started turning up in the ufo literature. When Jenny Randles says we were still struggling to make sense of the genetic code in 1967, she is playing deaf, both to the language used by Schirmer – he said 'breeding analysis', not 'genetic experimentation' – and to cultural history. Come to think about it, she was even being deaf about DNA. The structure of DNA was revealed in Nature in 1953 and James Watson's popular memoir The Double Helix was available in Signet paperback in 1968 - I still have a copy – and parts appeared in Atlantic Monthly in advance. So, let's drop the ahead-of-his-times prophetic allusions, please.

It is worth noting that Schirmer's revelation wasn't especially revealing. Unlike modern abductions he did not see rows of humans stored in tubes or offer drawings of incubatoriums filled with hybrid babies. It is just talk and kind of vague talk at that. Here is how it was first broached in the 1970 Warren Smith paperback:

"I was told that this was an observation craft and they collected samples of various types of animals and vegetables," Schirmer said. "Maybe I asked if they kidnapped people. I don't remember, except he said they had a program known as 'breeding analysis' and some humans had been used in these experiments. He didn't say if humans were kidnapped and taken away. We didn't discuss any further, probably because I didn't want them to get any funny ideas. (Norman 1970)

Oddly in the 1973 version, things become even vaguer. Consider the whole context: Williams asks, "Would you say they might have kidnapped people who might have stumbled onto their crafts?" Schirmer replies,

"I was informed they had picked up cows, dead bodies of animals and some people. These are used for experiments. There is a program of breeding analysis but it was not discussed to any extent. I think some people have been picked and changed so they may have agents in our world. They are very smart about the brain and how to change it." (Norman 1973)

The way things are arranged, if you had only this passage to work with, one could very easily conclude that the breeding analysis was meant to refer to the cattle that were picked up, not the people. The breeding of cattle is a normal concern of animal husbandry by humans. We are not told unambiguously that people are involved in the breeding analysis, only that aliens make agents out of some people. I consider this ambiguity notable for it might explain why, when one later abductee Carl Higdon uses the word breeding, it was not connected to humanity. This is Leo Sprinkle (S) regressing Higdon (H) in 1974:

H: He was talking about fishing and hunting – and exploring our country; he just kept talking. Nothing important, really, just small talk. Looking for birds, animals, they don't want nothing but humans.

S: Did he say want kind of animals they like?

H: No, just animals.

S: They want animals for food?

H: Food. Places to breed them on their planet. (Sprinkle 1979, p. 306)

Others, though, got it right. In a contact dated August 7, 1965 Fitozooloplanetologeico from Kristofix reveals there are 2,371,805 of their race among us and they have been studying the possibility of interbreeding with us. The experiencers were a gynecologist and two industrialists of San Pedro de los Altos, Venezuela.(Ganteaume1969; Bowen 1974)

In a journalistic investigation that appeared in a 1977 issue of Qui, an upscale competitor to Playboy, Glenn O'Brien reports asking a Tennessee ufo buff Colman Bever why he thought the aliens were on Earth, he banished the children to the back room and lowered

his voice.

"They are here for three things. One of them I'm not at liberty to tell you. Another is that they're picking out men of good health that they can work with, and they want the serum from the men so they can breed their women."

O'Brien learns the aliens were sterile from their nuclear war. At article's end he writes,

"the Plantos landed because they needed the biomatter of white Americans to shore up their radiation-damaged genetic heritage. They also arrived because the human race seemed to be endangering itself. The answer to both problems would seem to be, in Ingram's opinion, 'crossing races.' Simultaneously correcting the Plantos' radiation damage and endowing man with superior intelligence. Ingram also suspects that this process is being used to create a hybrid race, and wonders if certain of the aliens and certain earthlings are not already products of interstellar miscegenation."(O'Brien 1977)

John Williams, a 200 lb. ex-cowboy and non-practicing Cherokee, spoke of having a sexual experience with a cold yellow-eyed woman in December 1975. They are able to artificially induce great sexual desire to accomplish this. In a regression conducted by Dr. W.C. McCall, he senses the purpose is not romantic:

"They...They test...to help her people. The test...is to crossbreed" (Slate 1980)

Shane Kurz, another Seventies abductee complained under hypnosis

"Baby, he says. No, no. I don't want a baby. They want me to go and..you? Me? No, no! Freak! He says I'll be a good breed."(Holzer 1976; p. 234)

In the same book, Hans Holzer presents a re-interpretation of the Hill case abetted by channeling. Psychic Ethel Meyers in December 27, 1974 sits with Betty Hill and determines from the spirit of Barney,

"The aliens were trying crossbreeding experiments and through advanced surgery, grafting organs of earth beings onto their own kind and vice versa."(Holzer 1976; p. 157)

In a 1972 contactee book Elizabeth Klarer made revelations about her having union with Akon of Meton, (also called Venus II, the second planet from Proxima Centauri.) Though miscegenation has been previously unknown among his race, he states that his race needs new blood and chooses Klarer for "breeding experiments."

"It is very necessary after all these aeons of time; our race has become very inbred, despite our way of scientific breeding."

She fell deeply in love with him, became pregnant, and spent the last 4 months of it on his home planet. The child lived with her father. The story was recounted by Cynthia Hind in a better known paperback a decade later. (Hind 1982) The following year a tabloid writer heard about it and belatedly spawned one of the more memorable headlines of the decade. Space Alien babies were a popular recurring theme in tabloid stories of the early 1980s.

In addition to these first-person accounts validating the idea, some ufo writers inserted their own pre-occupations into the mix. In Chariots of the Gods, Erich van Daniken tells a story from the scroll of Lamech. Noah's father came home one day and *"was surprised to find a boy who, judging by his appearance, was quite out of place in the family."* He *"looked much more like a son of heaven than a man. His eyes, hair, skin, and whole being were unlike those of the rest of the family."* Enoch reveals he is a sign of a forthcoming great judgment and he would be the progenitor of those who would survive the great universal judgment. He is Noah. Asks Erich,

"Does not this seriously pose the question of whether the human race is not an act of deliberate 'breeding' by unknown Beings from outer space? Otherwise what can be the sense of the constantly recurring fertilization of humans by giants and sons of heaven, with the subsequent extermination of unsuccessful specimens?... Today, the possibility of breeding an intelligent human race is no longer such an absurd theory."(von Daniken, 1970)

He would revisit this idea repeatedly in his writings, eventually even descending into grotesque racist speculations.

"Was the black race a failure and did the extraterrestrials change the genetic code by gene surgery and then programme a white or yellow race...I am in complete agreement with the racial theorists, there was only the black race, which took its colour from the apes. But the change from black to white could not have been made with one mutation; it would need an endless chain of mutations. How does a new species appear, when only one is in existence? How could a washproof black become a white without interbreeding between two races?"(von Daniken, 1981, p. 70)

By the time Hopkins comes on the scene this habit of thinking had plenty of precedents in the ufo culture to build on. Synchronistically, in the same year as Intruders, the science fiction author Octavia Butler introduces her Xenogenesis trilogy. Its premiere installment, Dawn (1987), sets up the premise that on earth nuclear war triggered a nuclear winter that threatened a mass extinction. An alien race comes in and rescues some of the freezing remnants and, in trade, plans to use our biological materials. They find our cancers particular interesting and useful for their purposes. They are benevolent and open about the fact that they are a civilization



trading in biological knowledge and its advanced application. Their spaceships, homes, technology are all organic wherever possible. Metals and plastics have uses but are unusual. One human ponders her situation:

"But, no, it was not that kind of experiment. She was intended to live and reproduce, not to die. Experimental animal, parent to animals? Or... nearly extinct animal, part of a captive breeding program? Human biologists had done that before the war – used a few captives members of an endangered animal species to breed more for the wild population. Was that what she was headed for? Forced artificial insemination. Surrogate motherhood? Fertility drugs and forced 'donations' of eggs? Implantation of unrelated fertilized eggs. Removal of children from mothers at birth... Humans had done these things to captive breeders – all for a higher good, of course. (Dawn, p. 58)

Butler has been open about the sources of her inspiration stating that she realized as a teen while watching Devil Girl from Mars (1954) she could write better stuff and so started her Patternist series then and there.

"When I was in my teens, a group of us used to talk about our hopes and dreams, and someone would always ask, "If you could anything you wanted to do, no holds barred, what would you do?" I'd answer that I wanted to live forever and breed people – which didn't go over that well with my friends. (McCaffrey 1990; p. 61-2)

This was rooted in the sense that if you control breeding then you control the direction of life; a point that sociobiology partly clarified her intuitions on. Dawn reflects worries about the future of genetic engineering and the issue of hierarchical behavior as older thus more entrenched than intelligence. Can this be changed? Should it be changed? Is it the more self-destructive trait? In Adulthood Rites (1988), the first sequel to Dawn, the aliens create a new generation of mixing traits. These hybrids ask the aliens to give humanity a second chance at simply being human.

Abductees, in one form or another, continued to reinforce the attitude of alien estrangement. One amusing example comes in John Carpenter's August 13, 1991 regression of M.J., an adult female of Springfield, Missouri. She floats out of her bed and meets a 5'9" green, rough scaly being with pea-green eyes that show a yellow and black vertical slit.

"They need human beings to make them stronger, Trying to get our genes - threat of dying out. Inbreeding with us to see if what we have can make them stronger." (Howe 1993)

The term 'inbreeding' is incorrectly used here. It should be either 'outbreeding' or simply 'breeding.' Yet the error intends a moral opprobrium higher than merely breeding. The mistake feels appropriate.

A more typical form came in a nondescript abduction case in Puerto Rico. The experiencer floats up to a saucer and finds himself paralyzed in a metal chair. A group of 4 or 5 yellowy Grays mentally tell him *"they were here on a crossbreeding project between their race and our race and that it was vital for the survival of humanity."* (Martin 1991)

One of David Jacobs' subjects, Emily, in a 1993 regression remembers being assigned a handsome male hybrid as early as the age of 8 who tells her they will make pretty babies together. The assignment is consummated when she reaches the age of 15. Aliens remove her clothes, place her on a table, and inform her that they had been tracking and evaluating her and inform her that she is now *"ready to breed."* There are numerous subsequent encounters and they have sex at least twice per encounter. Her personal-project hybrid even had her bring a friend along to an abandoned NASA facility once so both could be bred. (Jacobs 1998)

John Mack's book Abduction, (1994) includes an abductee named Peter who spoke of his sperm being taken for the purpose of breeding with aliens. He's quoted as saying,

"It's not even about making love or sex," but "breeding with her" "I don't fucking believe I'm making love to an alien" (Mack 1994, pp. 319-20)

He is confused at how many children he may have conceived given how many sperm samples they've taken. The children will be used to repopulate the Earth after its destruction.

If you thought alien breeding claims died with the end of the millennium, it now appears they have resurrected and have grown gaudier. Among the latest wave of abductees, Michael Lee Hall has reported being told, *"You're a breeder"* by a girlfriend who doubled as a government operative for a secret group called the Labyrinth. She took a blood sample in a private moment and had it tested. She tells him it proved he is of the Nephilim / Anunnaki bloodline. (Lorgen 2013)

Rachel, an abductee claiming a missing fetus experience, speaks of her experiences as *"a beautiful chaos"* and asserts that drone-y grays are to blame: *"They use me for breeding – so, hybrid program."* (Cousins 2013)

Anya Briggs had a 2007 abduction experience

...they did things to me. They took ovum from me and they put me in a breeding program... I have been told that I am in fact part of a breeding program for telepathy. Specifically, I am a telepath. And that there are 27 others like myself and there were a group of benevolent grays who were participating in this with the -- The beings are telling me with the full participation of the U.S. government. And that I was part of an insurance policy in case the human race met an untimely end. That I was doing this as part of an insurance policy. They've done this for thousands of years. And that I have a hybrid child. There is a female hybrid child who is now about nine years of age. They accelerate aging. She was born about two years ago, but she is now genetically about nine years old. (Briggs 2010)

Hilary Porter and Kenneth John Parsons, founders of the British Earth and Aerial Mysteries Society, recently received attention when Hilary's weird abduction experiences were recounted on video. She's seen rows of jars of fetuses in a special hospital ward,

lost a baby she believes was taken by the grays, and met women who remember being with her in white room waiting on a bench. *"They are making hybrids."* They've been doing it for a long time, decades for certain. *"Their ability to reproduce has gone down the drain... They need our genetics."* She notes that they seem to favor people with certain categories of racial backgrounds – they may be interested in her Levitical Jewish bloodline. Other categories are Celtic, Romani Gypsies, and Indigenous peoples - Maori, Aussie aborigines, Red Indians. (Summerscales 2014) Her partner Ken adds, *"They tend to take females more for their eggs and genetic material for breeding purposes."*(Melville-Smith 2014)

It is mildly curious how political correctness has not stamped out all this talk of breeding. It always did have an aura of sexploitation about it, a decaying stench of the Nazi era and the taboo against racial ordering of people into inferior and superior types. This repetitive attitude of reducing men and women to a level even less than that as objects of sexual desire down to that of cattle, baby-making factories, and devices for creating slaves is one more or less inevitable in SF and horror. As Suvin has argued, all SF, virtually by definition, attempts to achieve a sense of cognitive estrangement. It throws one's perceptions into new patterns of interpretation.(Suvin 1976 - 1988) This partly explains why science fiction buffs hold ufology in such dis-regard. This breeding stuff just reeks of their pulp past and the badfilms that later spawned from it. To them, this id-sprung crypto-sexual horror isn't new at all.

Yet, to the historically naive, the choice of the word breeding sounds exactly considered, properly evocative of scientific distancing and objectivizing. It has the pragmatic attitude of animal husbandry with the end-product the whole concern. It is sex divested of emotions, no play, no romance, no courtship, no love. If you are dealing with business-like aliens who look down on us as all inferior, that should be the attitude, shouldn't it? Perhaps.

Though, perhaps too, not. To borrow a consideration from Gene Roddenberry's writings, shouldn't we demand compassion in our gods? If they have big brains, it should be easy enough for them to imagine the pain such an attitude would create in the victims of their experiments. If they are such experts at manipulating the brain as Herb Schirmer early said, couldn't they make the experience painless, even ecstatic?

I am unsure if ufo apologists consider all this talk of breeding among abductees after Schirmer a form of corroboration. It can certainly be granted it seems the one item of the Schirmer case that has been repeated the most often. I'm speaking of the word breeding specifically. Obviously if we started to include all the hybridization cases and sexploitative aliens as relevant we could multiply the length of this paper several-fold, but focusing on this one word embraces a clarity that helps our judging the import of Schirmer's revelation. As one can see, breeding by gray intelligences has a history that extends before the flying saucer culture was even born. Schirmer's use of it is immediately preceded by Lorenzen and comes at a time when alien breeding was coming at you from drive-in theatre screens. One hardly needs specialist knowledge to explain why the word kept popping up in the ensuing decades.

There is also a sense in which the breeding program still feels right because it expresses modernity as an embrace of whatever looks new.(Gay 2008) In a resonant yet creative way it rewrites the primordial science fiction horror text, Frankenstein, A Modern Prometheus. (Shelley 1818) The original project involves a hybrid creation, the combining of parts of several people to create new life. The alien hybrids are, in the contemporary rumor, our replacements.(Kripal 2011) They are rudely assembled from secret thefts with morally doubtful motives. They will survive in a new world. This can either be a distant utopia, or our world made new after a cataclysmic transition sweeps the old one away. It is Frankenscience distorted in the funhouse mirror of what we fear the future will bring. Shelley knew nothing of genes, of course, and the science of her time provides concepts that sound more like alchemy and magic to 20th century ears, but, time will draw its curtain on our contemporary language of horror in its turn. Indeed the bioscience of Intruders looked questionable almost immediately (Swords 1988).

In what I presume was merely a random foreshadowing, barely four years before Intruders and even less before meeting Hopkins, Whitley Strieber offered a nasty Gothic variant of this brand of Frankenscience in Night Church (1983). In it, an evil twin of the Catholic Church has been doing selective breeding experiments since the depths of the Dark Ages in an effort to create an anti-man to replace the defective species of homo sapiens. The Black Death was a premature attempt at our extinction and gargoyles a failed experiment in creating a monstrem. The book exists in an essentially religious cosmos and has only passing whiffs of the idioms of ufos and aliens. Hopkins's writings are pale shadows of what Strieber achieves in this book, but Hopkins deploys contemporary concepts and is constrained by the effort to seem factually futuristic.

It's not really necessary to suggest cross-fertilization between Strieber and Hopkins. As long as there are aliens involved, estranged sexuality was likely an inevitable conceptual development. Breeding and aliens was a combination seen well before the saucer era and the psychological and cultural forces in play are impossible to regard as mysterious.

SOURCES:

1. Otto Binder, *Flying Saucers Are Watching Us* Belmont Tower, 1968/70, p. 34.
2. Charles Bowen, "Saucer Central – Dreamlike Quality" *Saga's UFO Report*, 1, #6, Summer 1974, p. 8.
3. Anya Briggs with Mike Clelland, "Interview, part one" October 26, 2010 posted / conducted December 20-21, 2009: <http://www.hiddenexperience.podbean.com/2010/10/26/anya-briggs-interview-part-1/> Time index: 1:02:45 – 1:03:45.
4. Peter Brookesmith, *UFO-The Complete Sightings* Barnes & Noble, 1995, p. 92.

5. Peter Brookesmith, *UFO: The Government Files*, Barnes & Noble, 1998, p. 68.
6. Octavia Butler, *Dawn* copyright 1987; first paperback Warner Books, June 1988, [My copy is 1995]
7. Hadley Cantril, *The Invasion from Mars: A Study in the Psychology of Panic* Princeton U., 1982 [1940], pp. 36-8.
8. Blake Cousins, "UFO Sightings Aliens Abduct Two Girls Abducted for Hybrid Breeding! Shocking Claims Watch Now" *third-phaseofmoon*, March 16, 2013 http://www.youtube.com/watch?feature=player_embedded&v=O0wULA5R61s Time index 4:56
9. Dick Donovan, "I HAD A SPACE ALIEN'S BABY" *Weekly World News* July 12, 1983.
10. Francis Flagg, "An Adventure in Time" *Science Wonder Stories*, volume 1, number 11, April 1930, pp. 1018-36. Despite thematic parallels to AVB and Ralph Finn's *Captive on the Flying Saucer* building a good argument for direct influences by his story looks problematic. I suspect there are lost intermediating stories in the tree of relationships.
11. Peter Gay, *Modernism – The Lure of Heresy* WW Norton, 2008.
12. Horacio Gonzalez Ganteaume, "Landing at San Pedro de Los Altos" *Flying Saucer Review* 15, #2 1969, pp. 21-3.
13. Jennifer Michael Hecht, "Vacher de Lapouge and the Rise of Nazi Science" *Journal of the History of Ideas* April. 2000, pp. 285-304.
14. Jost Hermand, *Old Dreams of a New Reich: Volkish Utopias and National Socialism* Indiana University Press, 1992, p. 112.
15. Cynthia Hind, *African Encounters*, Gemini, 1982, p. 31.
16. Hans Holzer, *The Ufonauts* Fawcett Gold Medal, 1976.
17. Budd Hopkins, *Intruders*, Random 1987, p. 130.
18. Linda Howe, *Glimpses of Other Realities: volume 1, Facts and Eyewitnesses*, 1993, p. 295.
19. David Jacobs, *Secret Life*, Fireside, 1992, chapter 4.
20. David M. Jacobs, *The Threat*, Simon & Schuster, 1998, pp. 130-1, 178-9, 183-4, 185-6, 188-90, 197-98.
21. A.H. Johnson "The Thunderer" *Air Wonder Stories* January 1930; described in Everett F. Bleiler, *Science Fiction: The Gernsback Years*, Kent State University, 1998.; entry #666.
22. David H. Keller "The Conquerors, part 2", *Science Wonder Stories* volume, 1, number 8, January 1930. pp. 708-44.
23. Elizabeth Klarer, *Beyond the Light Barrier* Howard Timmons, 1980, pp. 135, 136-7, 142.
24. Martin S. Kottmeyer, "'The Invaders' (1935)" *The REALL News* 15, #3; March 2007; pp. 1, 4-5, 7.
25. Jeffrey J. Kripal, *Mutants & Mystics: Science Fiction, Superhero Comics, and the Paranormal*, University of Chicago Press, 2011, pp. 46, 322.
26. Coral E. Lorenzen *Flying Saucers: The Startling Evidence of the Invasion from Outer Space* Signet, 1966, p. 73:
27. Coral & Jim Lorenzen *Flying Saucer Occupants* Signet, July 1967, p. 206:
28. Eve Lorgen interview of Michael Lee Hill, May 8, 2013 <http://www.blogtalkradio.com/otherworldglobalnetwork/2013/05/08/eve-lorgen-interview-alien-abduction-experiencers-and-mind-c> Time index: 82:50 for quote
29. Anne McCaffrey, "Freedom of the Race," *Science Fiction Plus*, October 1953, p. 20.
30. Larry McCaffrey, *Across the Wounded Galaxies: Interviews with Contemporary American Science Fiction Writers* University of Illinois Press, 1990, pp. 54-70.
31. John Mack, *Abduction*, Scribner's, 1994, pp. 319-20.
32. Jorge Martin, *Enigma* # 46 as abstracted in *Lost Haven* website's *Humanoid case catalogue -- 1991 -- case 68: August 27, 1991; Barrio Quebrada De San Lorenzo, Puerto Rico.*
33. Alicia Melville-Smith, "Woman tells of her life plagued by UFO abductions including encounter in Cardiff" <http://www.walesonline.co.uk/news/wales-news/ufo-abduction-cardiff-woman-tells-7081853>
34. Michel Meurger, "Surgeons from Outside" *Fortean Studies* # 3 (1996) pp. 308-21.
35. S.B. Milcartz, "The Alien Stock Breeders." *Beyond Reality's UFO Special Issue* 1980, pp. 20-3, 66 Subtitle: "Did Villas Boas actually indulge in sexual intercourse with an alien woman in what seems to be breeding experiments, or did he hallucinate the strange encounter."
36. C.L. Moore & Henry Kuttner, "Earth's Last Citadel." *Fantastic Novels*, 4, #6, July 1950, pp. 24, 31, 43.
37. Eric Norman, *Gods, Demons and Space Chariots*, Lancer, 1970, pp. 185-6.

38. Eric Norman, *Gods and Devils from Outer Space*, Lancer, 1973, p. 150.
39. Glenn O'Brien's "The Saucermen of Tennessee and The Unspeakable Things They Did to Stanley Ingram's Daughter" *Oui* August 1977, pp. 90-108.
40. Martin S. Pernick *The Black Stork: Eugenics and the Death of Defective Babies in American Medicine and Motion Pictures Since 1915*, Oxford University Press, 1996.
41. Rog Phillips, "Incompatible" *Fantastic Adventures*, September 1949, pp. 84-98.
42. Jenny Randles, *Alien Contacts and Abductions* Sterling, 1993, p. 144-5.
43. Mary Wollstonecraft Shelley, *Frankenstein, or A Modern Prometheus* Lackington, Hughes, 1818
44. B. Ann Slate, "The Closest Encounter of the Third Kind" *UFO Report* 8, #4, August 1980, pp. 37-9, 77-8.
45. R. Leo Sprinkle, "Investigation of the Alleged UFO Experience of Carl Higdon" in Richard F. Haines, ed., *UFO Phenomena and the Behavioral Scientist* Scarecrow, 1979, pp. 225-357.
46. Whitley Strieber, *Night Church*, Simon & Schuster, 1983.
47. Joanna Summerscales, "AMMACH Witness Hilary Porter – Interview" March 18, 2014: <http://www.youtube.com/watch?v=WKVXnNjALdE> Time index 2:21:45 for making hybrids quotes; racial discussion runs 2:14:30 to 2:18:00.
48. Michael Swords, "Extraterrestrial Hybridization Unlikely" *MUFON UFO Journal* #247, November 1988, pp. 6-10.
49. Dark Suvin, "On the Poetics of the Science Fiction Genre" in Mark Rose, ed., *Science Fiction: A Collection of Critical Essays*, Prentice-Hall 1976, pp. 57-71.
50. Darko Suvin, *Metamorphoses of Science Fiction* New Haven, CT; 1979.
51. Darko Suvin, *Positions & Presuppositions in Science Fiction*, Kent State University, 1988.
52. Erich von Däniken *Chariots of the Gods* Bantam, 1970, pp. 42-3. It originally appeared in Germany in 1968.
53. Erich von Daniken, *Signs of the Gods*, Berkley, 1981, p. 70.

May 20, 1961: Tyndall AFB, Florida

NICAP lists the case as follows in the chronology:

*May 20, 1961--Tyndall AFB, Florida. Air Police observed unidentified light diving and climbing. [III]*¹

Section III has it listed in their table as air police reporting this case and that radar may have been involved.

*Radar-visual report, UFO maneuvered over base, dove and climbed. Reported by NICAP in summer 1961. Later analysis by Adviser Webb determined radar reports did not coincide with visual. Reports still unexplained. [Confidential report to NICAP Certified by NICAP Director, Ass't Director, and Adviser Walter N. Webb].*²

The UFO investigator of July-August 1961 provided more information about their source. It came from an AF report about the sightings. Not surprisingly, NICAP left out some details and amplified others they thought made the report appear exotic in nature

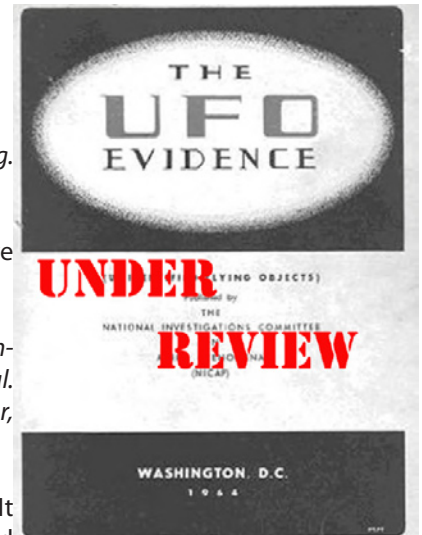

Blue Book case 7413

Blue Book reports that the observers had seen the UFO for about an hour and a half starting at 0250 local time (0850Z). The summary states the UFO was about the size of a softball, it moved downward and then upward. It also moved from NE to SE.

The file is composed of the various reports and details but the document cited by NICAP gives a good summary of what was seen. The four witnesses were three airmen and a staff Sergeant, who were part of base security. Their description of what they saw is slightly different:

a. *Airman Henson - On the morning of May 20, 1961 at approximately 0250 I saw this orange like light that came out of the woods. It first went up and then it backed down to tree top level and then went back up and stayed up at the same position for approximately ten minutes. Then it started moving toward me and then it would move back to the same position. It did this twice and then disappeared at 0430.*

b. *(ed: This is probably Airman Elmore but no name was given) At approximately 0300 hours, 20 May 1961 I heard Airman Henson call in to Tyndall via radio from Post #13 that there was a flying object around his post. Upon arrival, I noticed an unidentified object floating around in the air, moving back and forth, sideways up and down. When I left the scene at approximately 0330 hours, the object was still floating in the air. When I returned at 0500 hours, the object was no longer in sight.*

c. *Sgt. Mallet's report - I received a radio call from A/3C Henson, the guard at Post #13, Drone Launch site, located approximately 3 miles from Gate #2, Tyndall AFB. Airman Henson stated he could see an unusual light from his post. Airman Henson stated it was unusual to him because the light had moved several times. He further stated the light did not move in the normal course of an aircraft. I then proceeded to a boundary of the base at the east range and parked my AP vehicle to observe the light. I remained at that area until 0500 hours, 20 May 1961.*

d. *Airman Kelly's report - Intercepted a call from Post #13 about a floating object. Car #3 said he would check. At about 0400 hours I no-*

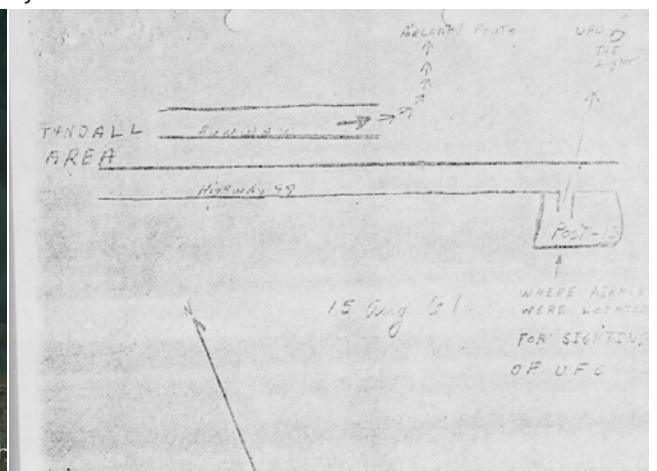

*ticed a bright shining object about 30 degrees from horizontal and it did not appear to be moving. On closer observation I noticed that it was moving west slowly. I went to the Drone Launch site to exchange vehicles and continued to see it.*³

Post #13 appears to have been at the “Drone Launch site”, which still exists today. This is about two miles beyond the end of the main airstrip on the south side of the road US-98. If one examines the sketch, the witness appears to have been looking at a direction of about 50-70 degrees, which is more ENE than NE.⁴ Because the airstrip runs from NW to SE, there may have been confusion about where precise north was located. It is also important to note that this sketch apparently was drawn on August 15th, which brings up some concern about how good these statements are.

The main report was filed on May 23rd but there seemed to be a follow-up investigation in August, where the witnesses filled out statements regarding what they saw. What apparently occurred was Master Sergeant Lacour had interviewed the witnesses that morning and evening and had written this report based on his notes from these interviews. On August 14th, Lacour had a phone conversation with Dr. Hynek and Blue Book, which prompted the acquisition of written statements by the witnesses.⁵

This table of the initial report can assist in evaluating the sighting.⁶

Witness	Azimuth	Elevation	Size	Color	Description
Henson	30-40 deg		softball - round	Rusty orange or bright white	it disappeared at a 90 deg angle slow to the southeast. Went in opposite direction of alert aircraft and shot straight up.
Elmore	30-40 deg		softball (shaped like helicopter)	orange to bright white	Shaped like a helicopter.
Mallet	70-130 deg		basketball - round	More brilliant than a star or meteor.	Gained altitude slowly and disappeared from view.
Kelly	60	30	Large light big as a fingernail on little finger at arms length. Irregular shape.	white with blue tint.	Moved slowly west and faded out

The azimuth and elevation reports are very difficult to determine since MSgt Lacour did not specify which was which. Mallet’s observations indicated he was describing azimuth since elevation can only be as high as 90 degrees so the values given appear to have been azimuth.

No reports were made by the local or state police. There was also no reports from Fannin field, which was the local airport for Panama City. This indicates the event must have been either localized so only these individuals could see it or the object was something that others recognized to be mundane.

Radar contact

There was a mention of radar contact being detected. A jet fighter was scrambled and they had an intermittent radar contact. However, the pilot saw nothing visually. Because the radar contact was slowly moving, a helicopter was sent up but they also saw nothing.⁷

There seemed to be no reason to suspect that the radar contact was the same object as reported by the witnesses and may have been just a case of anomalous propagation conditions or some sort of false return. To NICAP’s credit, they dismissed this part of the event.

Blue Book’s solution

Blue Book decided what the observers saw was the planet Venus. This explanation has merit when examining the observations by the airmen. Venus rose at azimuth just north of east at 0245 CST on May 20th. This was only five minutes before the witnesses reported the object being visible in between the trees. It was just south of east at the time of sun rise (446CST), which is about the same time the witnesses stated the UFO disappeared. Venus, at magnitude -4.2 would have remained visible in the dawn sky until the sun rose. At that point, Venus would have been lost in the glare of strong twilight/daylight. This table provides azimuth and elevation for Venus on the 20th of May, 1961 from Tyndall AFB:

Time	Az	EI
0850Z (0250 CST)	83	1
0930Z (0330 CST)	88	10
1000Z (0400 CST)	92	16
1030Z (0430 CST)	96	22
1100Z (0500 CST)	100	29

The trees/woods in Florida that line these roads are tall thin pine trees. One can see between the individual trees as long as they are not packed close together. The more distant treeline is only a few degrees above the horizon and are probably what Airman Henson was referring to when he described the object being at tree top level when it first became visible.

The big question is, why didn't the observers know this was the planet Venus and why didn't they see Venus before or after? There could be several reasons. The first could be this was the first time the airmen had the early morning shift in several weeks. It was not unheard of to have the security guard teams rotate shifts. Additionally, the weather may have been poor on those days they did stand the morning shift, which would have prevented them from seeing Venus. Another factor to consider is these security guards were airmen, which are the lowest grade and youngest members of the military. The initial observer was Airman third class Henson, who was an E-2 and probably had been in the USAF for about 6 months to a year. He simply saw this unusual light and reported it. After it got onto the radio net, other airmen noticed the light as well. It is up to the senior members of the security team to evaluate what they report. In this case, it was Sergeant Mallet. He chose to go to the east range and observe the object. He noted nothing unusual in his report other than it would move side to side and up and down. He also noted that it slowly gained altitude and moved from NE to SE during a two hour time period.

Solved?

While we can never positively identify such UFO cases, this one has a good chance of being the planet Venus. There are several factors that indicate the object was probably Venus:

1. The observers never reported seeing the object and Venus.
2. The object faded as the sun rose
3. The Azimuths reported are in the general direction of Venus.

Many of the effects described by the witnesses are often seen in witness reports of astronomical objects. Autokinetic and atmospheric effects seem to have played a role in their observations. There is no good reason to dismiss Venus as the cause for these reports and, it appears, that Blue Book got this one right.

Notes and references

1. Hall, Richard M. (Ed.) The UFO evidence. The National Committee on Aerial Phenomena (NICAP). New York: Barnes and Noble. 1997. P. 139.
2. *ibid.* P. 22
3. "Report on Unidentified Flying Object (UFO)". 23 May 1961. Fold 3 web site. Available WWW: <http://www.fold3.com/image/8684652/> and <http://www.fold3.com/image/8684662/>
4. "Additional Information on UFO 20 May 1961". 18 August 1961. Fold 3 web site. Available WWW: <http://www.fold3.com/image/8684829/>
5. "Additional Information on UFO 20 May 1961". 18 August 1961. Fold 3 web site. Available WWW: <http://www.fold3.com/image/8684774/>
6. "Report on Unidentified Flying Object (UFO)". 23 May 1961. Fold 3 web site. Available WWW: <http://www.fold3.com/image/8684662/>
7. "Report on Unidentified Flying Object (UFO)". 23 May 1961. Fold 3 web site. Available WWW: <http://www.fold3.com/image/8684664/>

701 Club: Case 2692 August 27, 1953

Don Berliner's description is rather brief:

Aug. 27, 1953; Greenville, Mississippi. 9:45 p.m. Witnesses: USAF pilot, M/Sgt., others, all on the ground. One meandering light was observed for 50 minutes. No further details in file.¹

While he states there are no further details in the file, the file actually contains fourteen pages of information including a few maps and sketches of how the object moved over the time period by two of the principle witnesses.

The Blue Book file

1. DATE - TIME GROUP 27 August 53- 08/09453	2. LOCATION Greenville, Mississippi
3. SOURCE Military & Civilian	10. CONCLUSION UNIDENTIFIED
4. NUMBER OF OBJECTS One	11. BRIEF SUMMARY AND ANALYSIS Broken clouds at 5,000 ft., with 8 miles visibility. Checks revealed no a/c in vicinity. No major astro body in SW. Antares sighting. Case Unidentified. Circular object emitted red, green and white alternate flashes of light for approx 3-4 seconds, then a steady red flash of light diminishing as increasing in distance. Object was traveling from SW to West. Observers stated that object appeared to be rotating. Manner of disappearance, obscured by clouds.
5. LENGTH OF OBSERVATION 50 Minutes	
6. TYPE OF OBSERVATION Ground-Visual	
7. COURSE SW to W	
8. PHOTOS <input type="checkbox"/> Yes <input checked="" type="checkbox"/> No	
9. PHYSICAL EVIDENCE <input type="checkbox"/> Y 27 Aug Greenville AFB, Miss Antares? <input checked="" type="checkbox"/> N	b-5

FORM
FTD SEP 63 0-329 (TDE) Previous editions of this form may be used.

Blue Book's summary card states the following about the case:

Circular object emitted red, green, and white alternate flashes of light for approx 3-4 seconds, then a steady red flash light diminishing as increasing in distance. Object was traveling from SW to West. Observers stated the object appeared to be rotating. Manner of disappearance, obscured by clouds.²

The summary card stated the object was visible for 50 minutes starting around 0315Z (2145 PM CST). Out of the fourteen remaining pages, the most important is the collection of statements by three of the witnesses.

The first came from a Master Sergeant Cooper, who saw the UFO from his home. Master Sergeant Cooper's observations, which he made out his bedroom window, included a sighting map for his UFO and a sketch of the UFO's path against the sky. The map indicates the azimuth was roughly 315 degrees. His description included the following comments:

The unidentified object was similar to a large star, but seemed to be rotating and emitting alternate green and red flashes, and moving slowly north and downward on the horizon...I first sighted the object at 2145 hours Central Standard Time on 27 August 1953. Obscured by clouds and it was lost from sight at 2235 hours Central Standard Time.³

Cooper, mystified by what he was seeing, called the Greenville AFB duty officer, who then chose to go to the control tower with Airman MacDonnell and Arceneaux. There is no statement by MacDonnell but Arceneaux did file a report:

It didn't appear very large from our view point. Its color was sort of green, red and slight yellow...it moved very slowly from my vantage point. Its movement were but moving westward movement at approximately the same altitude, it just seemed to fade away into the night. It moved about ten (10) to fifteen (15) degrees from southwest to the west...I sighted the object from the control tower at 2230 hours until 2300 hours in the southwest with westward movement. At 2310 hours, I notified Memphis Control, and they stated no aircraft were in the area at 2312 hours. At 2300 hours it disappeared.⁴

Captain Lehman's brief report stated:

The unidentified object emitted red and white flashing light diminishing as if increasing in distance...I first sighted the object at 2230 after receiving a call from M/Sgt T. O. Cooper. We observed the object from 2230 hours until 2300 hours hovering on the horizon...object seemed to move very slowly.⁵

This is how the file ends. The investigating officer simply put it all together and sent it to Blue Book, who filed it away as unidentified because they did not bother to look much further than that.

Possible solution

There are two different sightings in this case. Blue Book felt they were of the same object but I think they actually involved two different astronomical objects.

The first sighting was by Master Sergeant Cooper. He observed his object from 2145 to 2235. According to his sketch, he was looking northwest out his bedroom window. However, there are some issues with his description that indicate this direction was not correct.

In his sketch, the address of his location was blotted out in the Fold 3 site.⁶ However, the Blue Book archive web site has the unredacted copies. They give his address as "353 Thomas Road" in Greenville.⁷ We can now possibly visit his location using Google Earth. If one uses the ground level view, we can determine that Cooper was on the west side of the road, which means he was looking outside the rear of his house.

The view of the neighborhood from the historical aerials web site was taken from the air in 1967.⁸ It is not a direct representation of what it looked like in 1953 but it is closer than the google images from the present era.⁹ There is a noticeable lack of trees in the neighborhood compared to more recent imagery. This may be due to the resolution or time of year but it appears to indicate that Cooper had a relatively unobstructed view of the horizon. The only exception was an electrical power pole he could see from his window that he would use for a reference point in his observations.

It is interesting to point out that behind his home was a south to north dirt road where, today, there are power poles with electrical lines running along the road. These probably existed back in 1953 as well. There is one power pole behind his house that, depending on what end of the house his bedroom window was, lies at an azimuth of 275-300 degrees. He estimated the distance to the pole as being 120 feet, which is pretty close to the distance from the rear of the house to this power pole circled in Yellow in the Google Earth image on the previous page. Assuming this was his reference point, this indicates he was not looking towards the

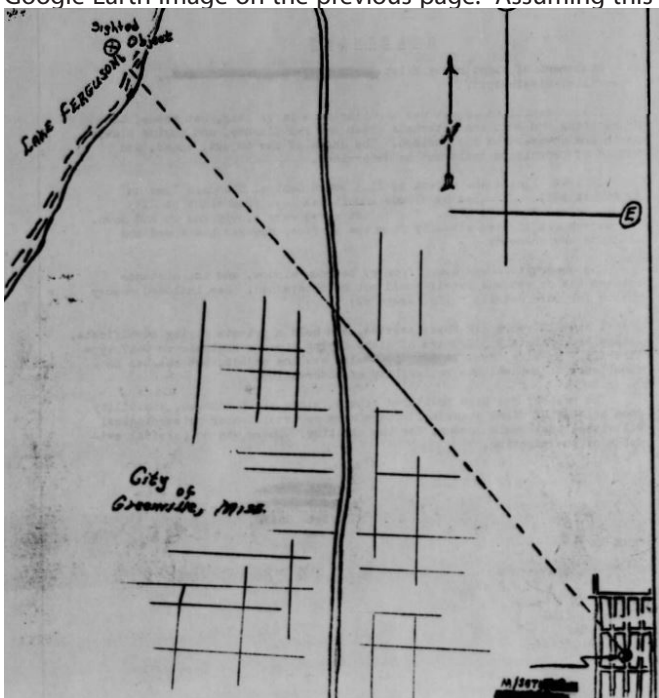

northwest but more towards the west or west-northwest.

The UFO moved behind this pole over the period of fifty minutes outside his window.¹⁰ When I first saw this sketch, the amateur

and the amount of resources allocated to investigating this case seems to have been minimal.

Solved?

While we can not conclusively prove that these sightings were caused by Arcturus and Antares, there is good reason to suspect that this was the case. I consider this event reclassified as “probably Arcturus and Antares” and taken off the Blue Book “Un-identifieds” list.

Notes and references

1. Berliner, Don. “The Bluebook unknowns”. NICAP. Available WWW: <http://www.nicap.org/bluebook/unknowns.htm>
2. “Project 10073 record card”. Fold 3 web site. Available WWW: <http://www.fold3.com/image/6979600/>
3. “Air Intelligence Information Report ATRC-IR-33-53” page 3 of 9 Fold 3 web site. Available WWW: <http://www.fold3.com/image/6979621/>
4. “Air Intelligence Information Report ATRC-IR-33-53” page 6 of 9 Fold 3 web site. Available WWW: <http://www.fold3.com/image/6979626/>
5. “Air Intelligence Information Report ATRC-IR-33-53” page 8 of 9 Fold 3 web site. Available WWW: <http://www.fold3.com/image/6979630/>
6. “Air Intelligence Information Report ATRC-IR-33-53” page 4 of 9 Fold 3 web site. Available WWW: <http://www.fold3.com/image/6979619/>
7. “Air Intelligence Information Report ATRC-IR-33-53” page 3 of 9 Project Blue Book Archive. Available WWW: <http://www.bluebookarchive.org/page.aspx?PageCode=MAXW-PBB19-910>
8. 1967 Aerial photograph of Greenville, Mississippi. Historical Aerials. Available WWW: <http://www.historicaerials.com/aerials.php?scale=2000&lon=-91.037803649902&lat=33.398441314697&year=2004>
9. Google Earth Software. Available WWW: <http://www.google.com/earth/download/ge/agree.html>
10. “Air Intelligence Information Report ATRC-IR-33-53” page 5 of 9 Fold 3 web site. Available WWW: <http://www.fold3.com/image/6979623/>
11. “Air Intelligence Information Report ATRC-IR-33-53” page 7 of 9 Fold 3 web site. Available WWW:<http://www.fold3.com/image/6979628/>

UFOs on the tube

Close Encounters

This series had been criticized by numerous individuals and I finally got a chance to see why. In each 30 minute program, the producers managed to cover two UFO cases by dramatizing the events and having two "experts" describe the case.

The first episode involved the Yukon 1996 mothership case. What was ignored (or never recognized) in the program is that the same UFO was seen over a stretch of road over 100 miles in length. In SUNlite 6-2, I pointed out that problems with this information but Jasek/Rutkowski fail to explain how they all could have seen the object around the same time frame and in the same general direction. This implies the object was not close but very high and far away. The real identity of the UFO report was the re-entry of the rocket booster for Cosmos 2335, which was not even hinted at in the program. This set the tone for all the other episodes where the producers feared mentioning any explanation for the cases they were promoting.

The next case was the Malmstrom Oscar flight missile shut down. While Leslie Kean and Kevin Randle seemed to know the minute details of the case, they fail to mention that there is not one record to indicate that Oscar flight had any shut down. The primary source for details about this case is the testimony of Robert Salas, who, initially, could not even remember which flight he was on or when the event supposedly occurred. Originally, he thought he was part of Echo flight, which did have a missile shut down. That event is well documented but when Salas found out he wasn't there, he started stating it also happened on his flight and UFOs were involved. I found the presentation of airmen from security scared out of their wits and crawling on the ground because of an orange light rather disturbing and completely inaccurate. This story is essentially a folktale and can not be verified to have actually happened.

The Rendlesham case was presented by Leslie Kean and Nick Pope. In an effort to give credence to the tale told by Jim Penniston, Kean described him as the head of security and Pope declared he was an aviation specialist/expert. As a security "specialist", Penniston probably had only a few months training for his job rating but he wasn't even in charge of his own shift. He did not perform maintenance on, or fly, aircraft and he answered to superior officers and enlisted men, who were actually in charge of base security. These exaggerations indicate Kean/Pope were either uninformed or deliberately misled the viewer. The show stated airman Cabansag did not go with Penniston and Burroughs, but we know that is not true since all the statements from 1981 state that all three went into the woods. They also were unarmed but the program portrayed them carrying M-16s as if they expected a fire fight. The rest of the story is told from the testimony of Penniston. It was not surprising that the lighthouse chase described by Burroughs and Cabansag, in their 1981 witness statements, was never mentioned.

The series had other cases, where completely inaccurate information was presented. Larry Lowe stated that the March 13, 1997 Arizona UFO case was caused by multiple triangles flying over the state but no witnesses reported seeing more than one. The varied descriptions had more to do with how witnesses saw the same stimulus (a formation of aircraft) in different ways. The Kecksburg episode simply repeated James Romansky's story. It is important to point out that Romansky can't even prove he was there and that his questionable past does not make him a very reliable witness. The real fire chief from the time period is on record as stating this story was fabricated. Not surprisingly, Leslie Kean and Stan Gordon chose not to mention this even though they probably are well aware of this information. There is no convincing evidence that supports their claim that a massive military effort occurred that night, which is a major hole in their story.

This series can't be really considered an objective look at these UFO cases without presenting possible explanations. The producers of the program were guilty of promoting UFO propaganda. It is a shame the program was shown on a channel supposedly designed to promote "science".

Buy it, Borrow it, or Bin it

Encounter in Rendlesham Forest:
- Nick Pope, Jim Penniston, and John Burroughs.

Don't let the list of authors fool you. The real author of this book is Nick Pope. Penniston and Burroughs add one chapter about their story but it is Pope that force feeds his version of the Rendlesham incident down the reader's throat.

I found a good deal of what Pope wrote was nothing more than a rehash of the same old arguments. There is no reason to repeat the entire case here but I found it hilarious that Pope used the old tired argument that the 1981 statements by the witnesses were ALL "watered down". While Penniston and Burroughs have made this claim, no such claims were made by Buran and Chandler. There would be no reason for them to lie about what happened and their accounts pretty much agree with what Penniston and Burroughs reported in their statements. This is something ignored/not mentioned by Pope and the other promoters.

Pope attempts to dispose of the explanation offered by Ian Ridpath. He focuses on the lighthouse and proclaims that skeptics use that to explain everything, which is not the case. Not surprisingly, Pope congratulates himself for eliminating the skeptical arguments even though his rebuttals fail miserably.

In his chapter of "Beyond Rendlesham", Pope tries to put together some UFO cases that "impress" him. However, Pope ignores a lot of details that explain these cases. That makes Pope guilty of not really doing any research beyond what he chooses to believe. It is easy to be impressed if you don't look beyond the headlines.

The chapter by Burroughs and Penniston is what one expects. It is another case of them begging for people to believe what they have to say no matter how crazy they sound.

This book offers nothing new and is just an effort to keep the Rendlesham story alive. I feel I wasted my money in purchasing it on Kindle. This is a bin it book.